



# AKU SHAPER

Customer:

Date:

Jan 19, 2010

Length:

5' 10 1/8" (1781.1)

Width:

18 " (457.2)

Thickness:

1 7/8" (48.1)

Tail Stop:

35 7/16" (900.0)

Designed by: Octopus

File: AGroShape2

Blank:

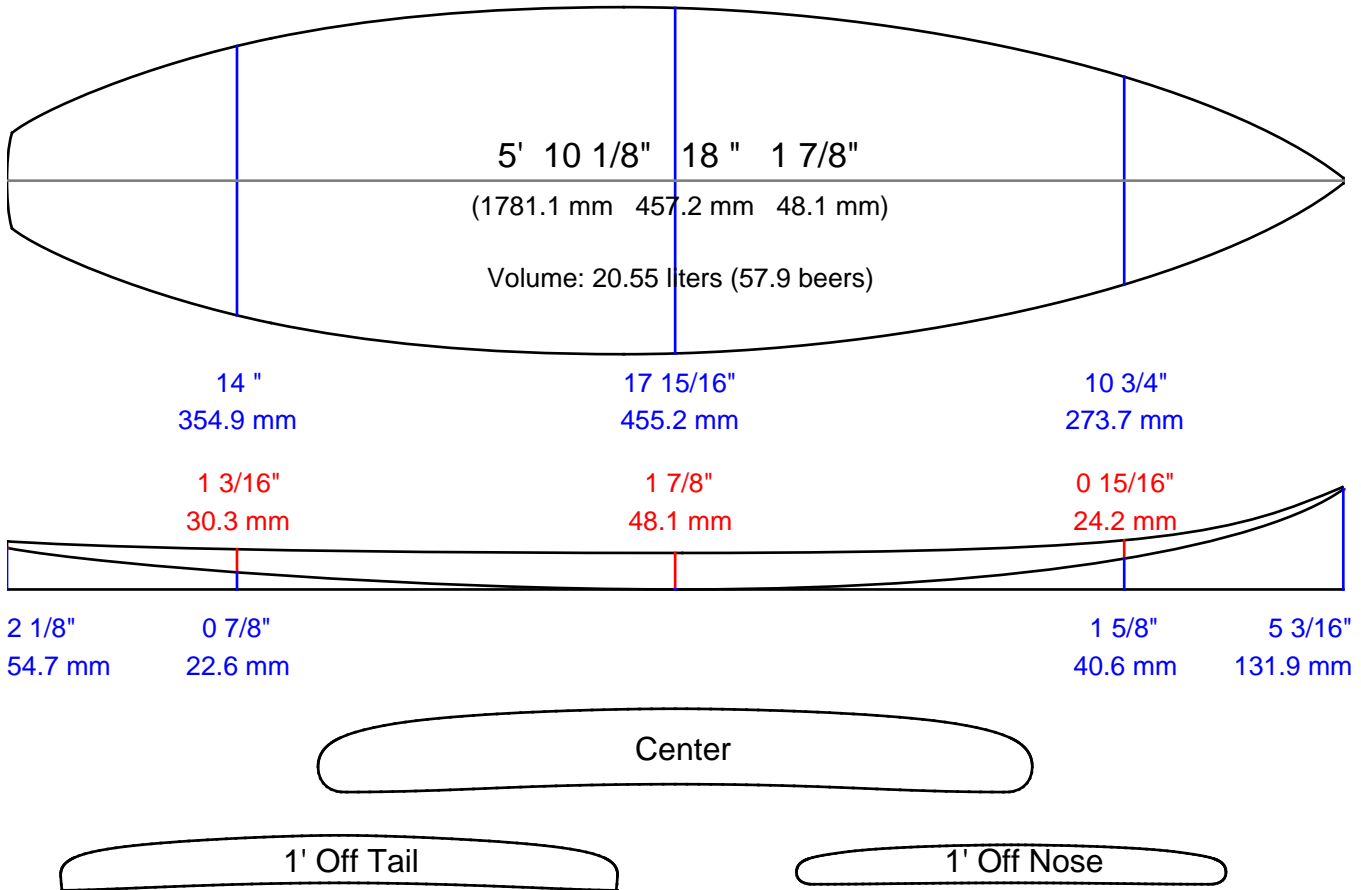

Measurements are center, one foot in and one foot back, over curve.

### Comments:

Similar to CI Alex Gray custom model.

ORIGINAL. Back fin at 3.375, Side fins at 10 13/16, 1.125 off rail, 3/16 tow.



# AKU SHAPER

Customer:  
 Date: Jan 19, 2010  
 Length: 5' 3 7/8" (1622.1)  
 Width: 17 1/2" (444.5)  
 Thickness: 1 7/8" (47.9)  
 Tail Stop: 35 7/16" (900.0)

Designed by: Octopus

File: BamBamShape  
 Blank:

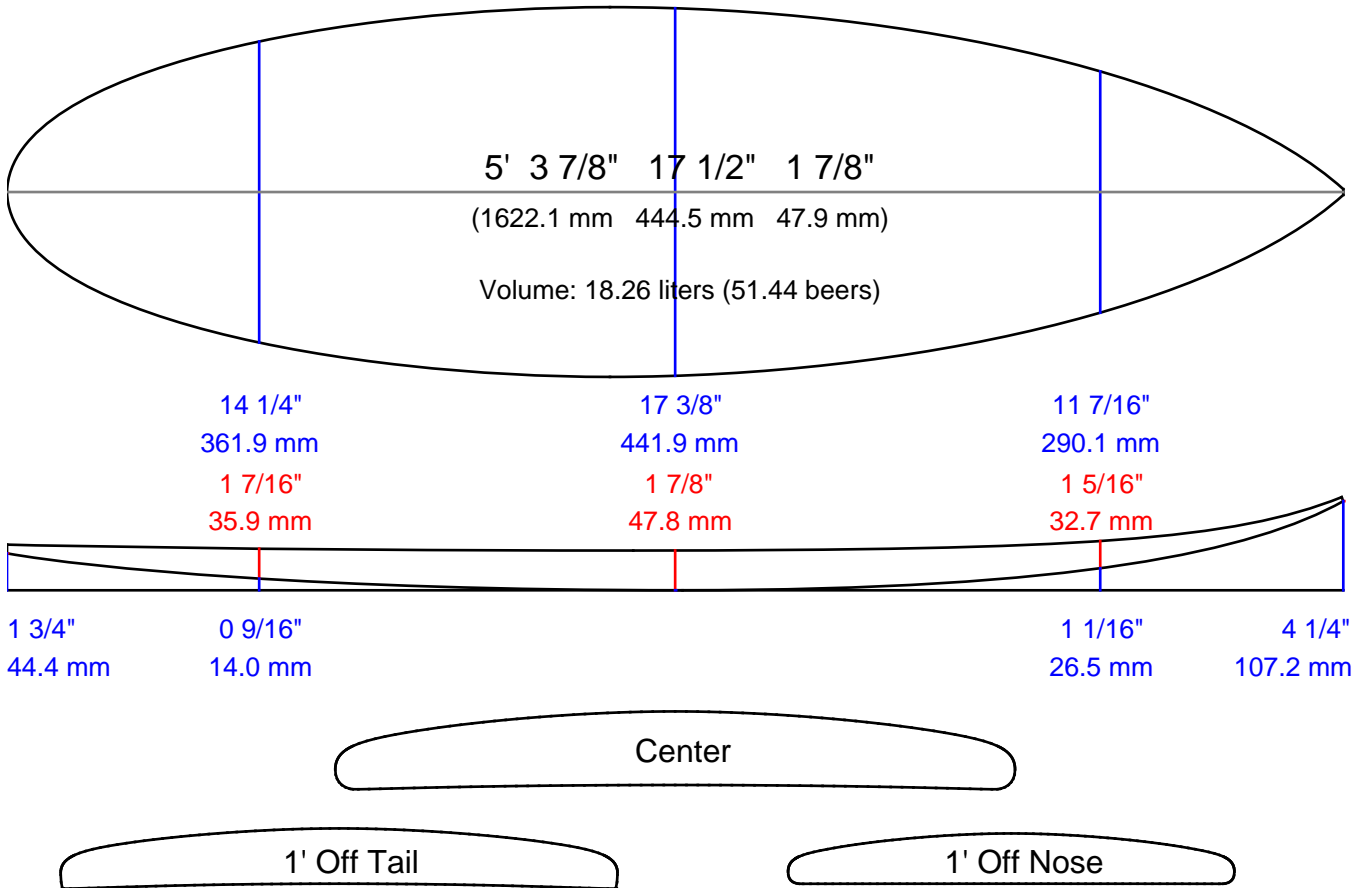

Measurements are center, one foot in and one foot back, over curve.

### Comments:

Front fin at 10.5, 1-3/16 off, 1/4 tow. Back fin at 3-5/16. ORIGINAL



# AKU SHAPER

Customer:

Date: Jan 19, 2010

Length: 6' 2" (1880.9)

Width: 18 5/16" (465.1)

Thickness: 2 1/8" (53.9)

Tail Stop: 35 7/16" (900.0)

Designed by: Hopper

File: BandidoShape

Blank:

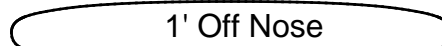
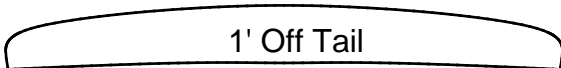
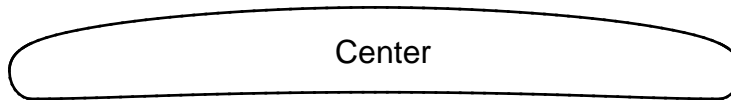
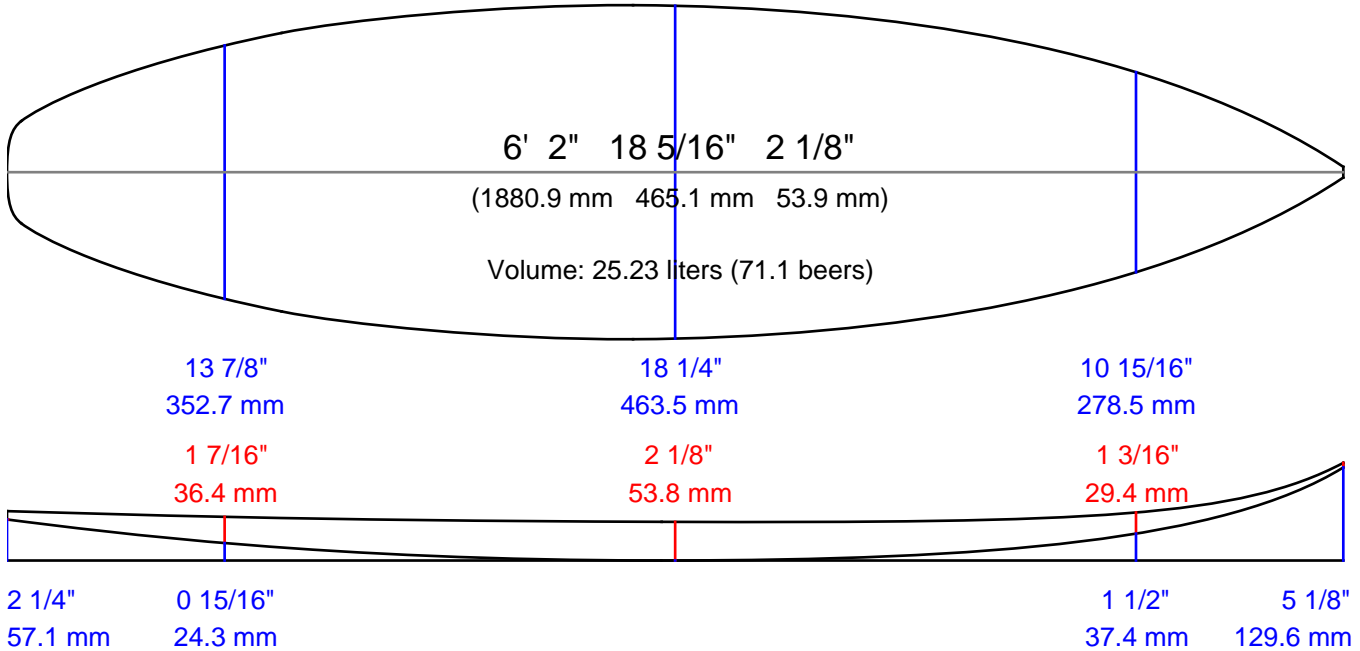

Measurements are center, one foot in and one foot back, over curve.

**Comments:**

Similar to BH magic Robert's.

Side fin at 11-1/8, 1-1/8 off rail, 1/4 tow.

Back fin at 3-3/8.



# AKU SHAPER

Customer:

Date: Jan 19, 2010

Length: 6' 0 3/4" (1848.4)

Width: 18 13/16" (477.5)

Thickness: 2 5/16" (58.1)

Tail Stop: 0" (0.0)

File: CaliforniaShape2

Designed by:

Blank:

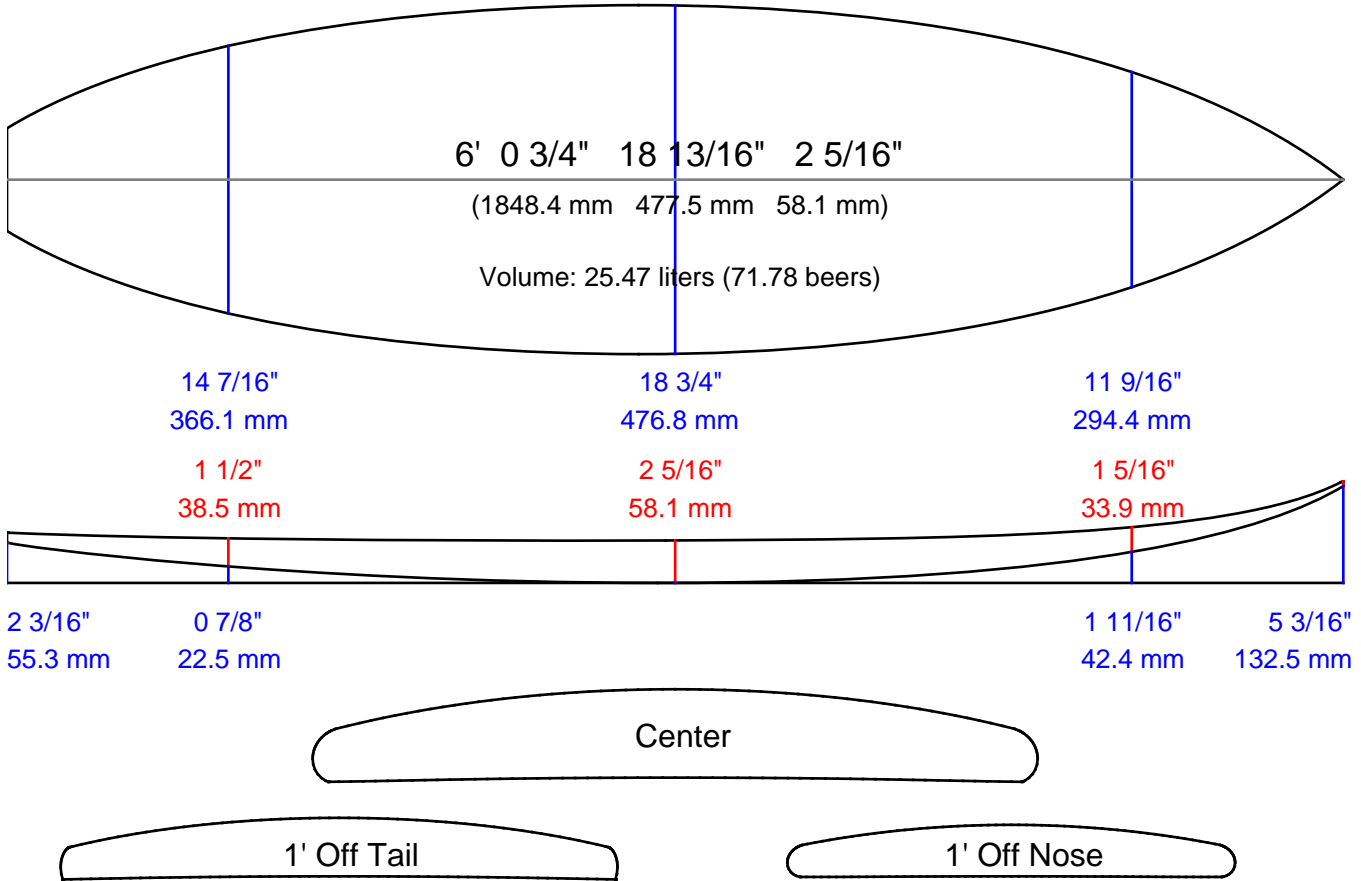

Measurements are center, one foot in and one foot back, over curve.

**Comments:**

Similar to custom JC model.



# AKU SHAPER

Customer:

Date: Jan 19, 2010

Length: 5' 9" (1751.5)

Width: 18 5/16" (465.1)

Thickness: 2 1/16" (51.7)

Tail Stop: 35 1/4" (895.0)

Designed by: Hopper

File: DemonShape3

Blank:

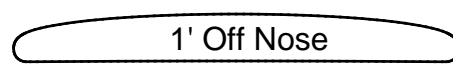
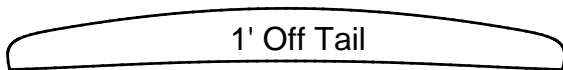
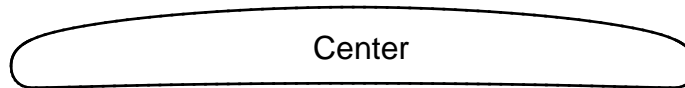
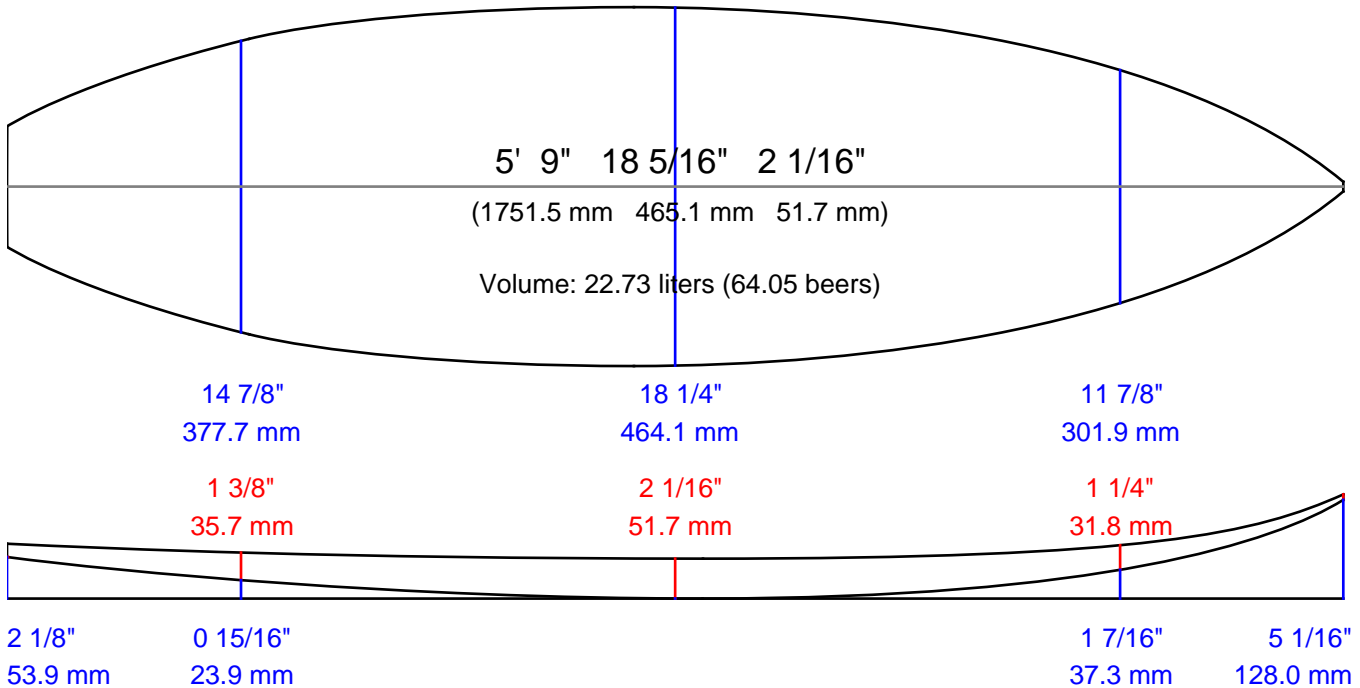

Measurements are center, one foot in and one foot back, over curve.

**Comments:**

Similar to Machado's CI Flyer 2.

Best with 1.55" deep swallow tail.

Back fin at 3.5

Side fins at 10-5/8, 1.5" to inside of Future Box.



# AKU SHAPER

Customer:

Date: Jan 25, 2010  
Length: 6' 2 1/4" (1886.2)  
Width: 18 5/8" (472.7)  
Thickness: 2 3/16" (56.0)  
Tail Stop: 0" (0.0)

Designed by:

File: ExponentShape  
Blank:

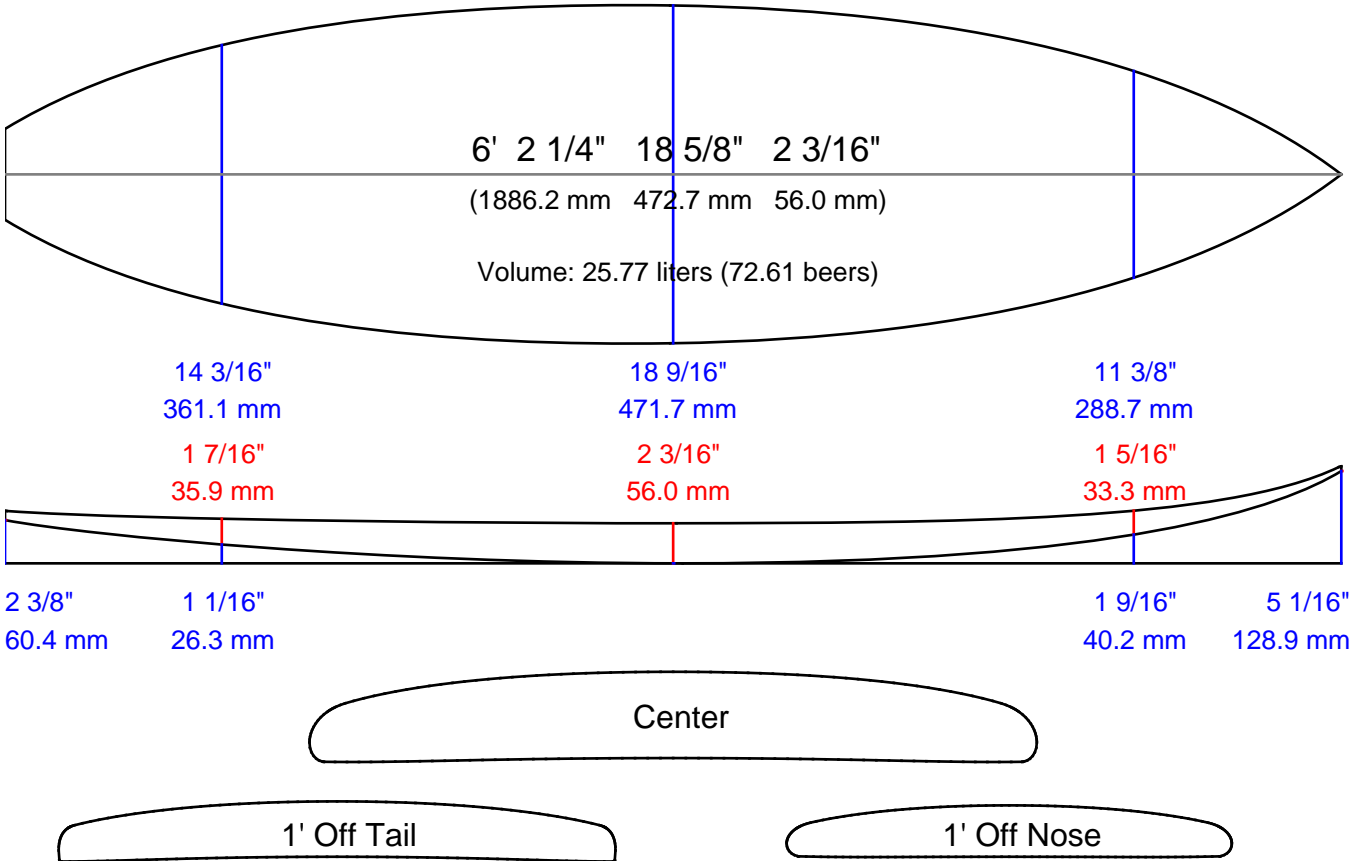

Measurements are center, one foot in and one foot back, over curve.

**Comments:**

Similar to custom JC model.



# AKU SHAPER

Customer:  
 Date: Jan 19, 2010  
 Length: 6' 1 1/8" (1858.1)  
 Width: 18 3/8" (466.7)  
 Thickness: 2 3/16" (55.6)  
 Tail Stop: 35 7/16" (900.0)

Designed by: Octopus

File: FijiShape  
 Blank:

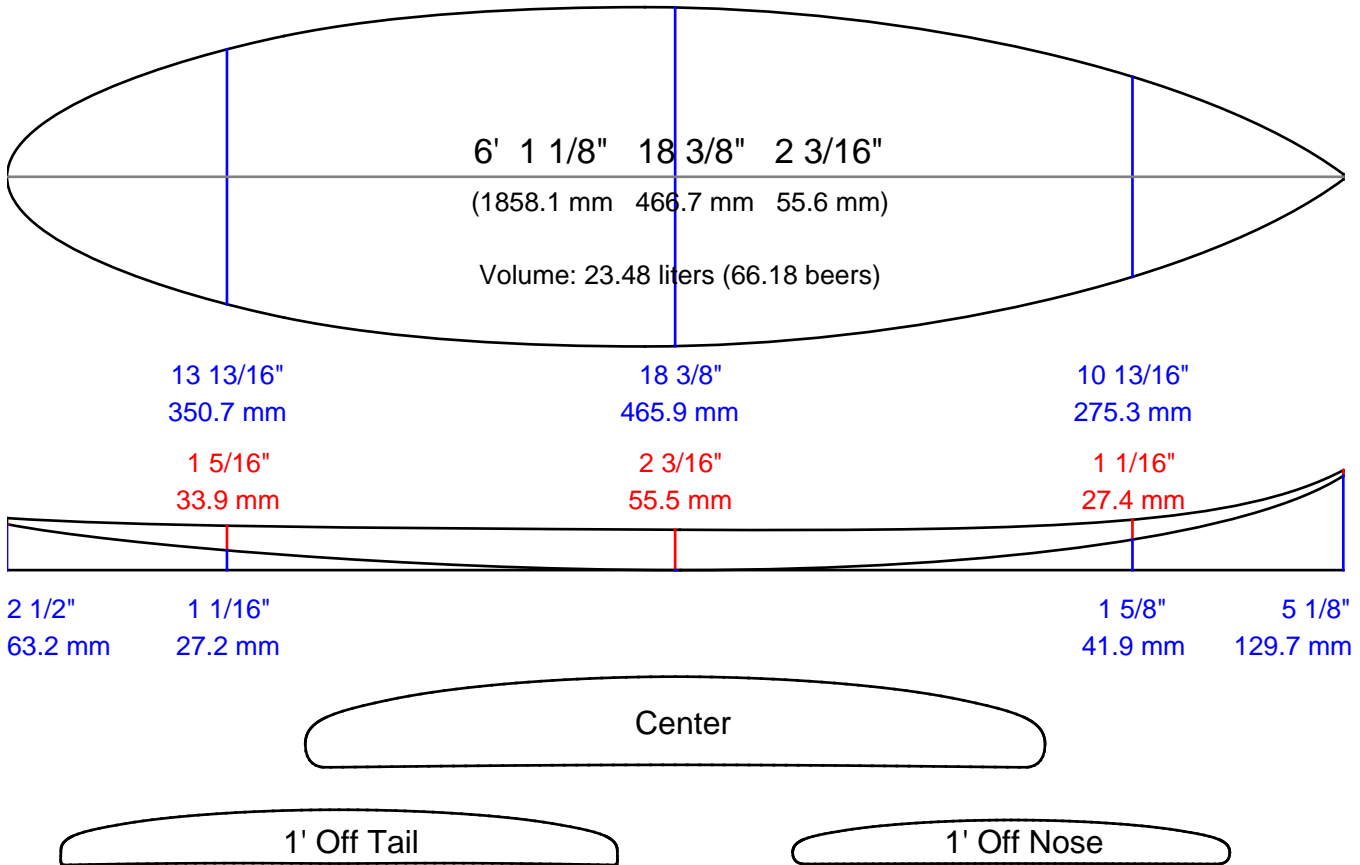

Measurements are center, one foot in and one foot back, over curve.

**Comments:**

Similar to CI Slater Board from Fiji 2008.  
 Back at 3.5  
 Side at 11-1/8, 1-1/4 off rail, 1/4 tow.



# AKU SHAPER

Customer:

Date:

Jan 19, 2010

Length:

6' 5 3/8" (1965.6)

Width:

18 1/4" (463.5)

Thickness:

2 1/8" (54.3)

Tail Stop:

35 7/16" (900.0)

Designed by: Octopus

File: FijiStepUpShape

Blank:

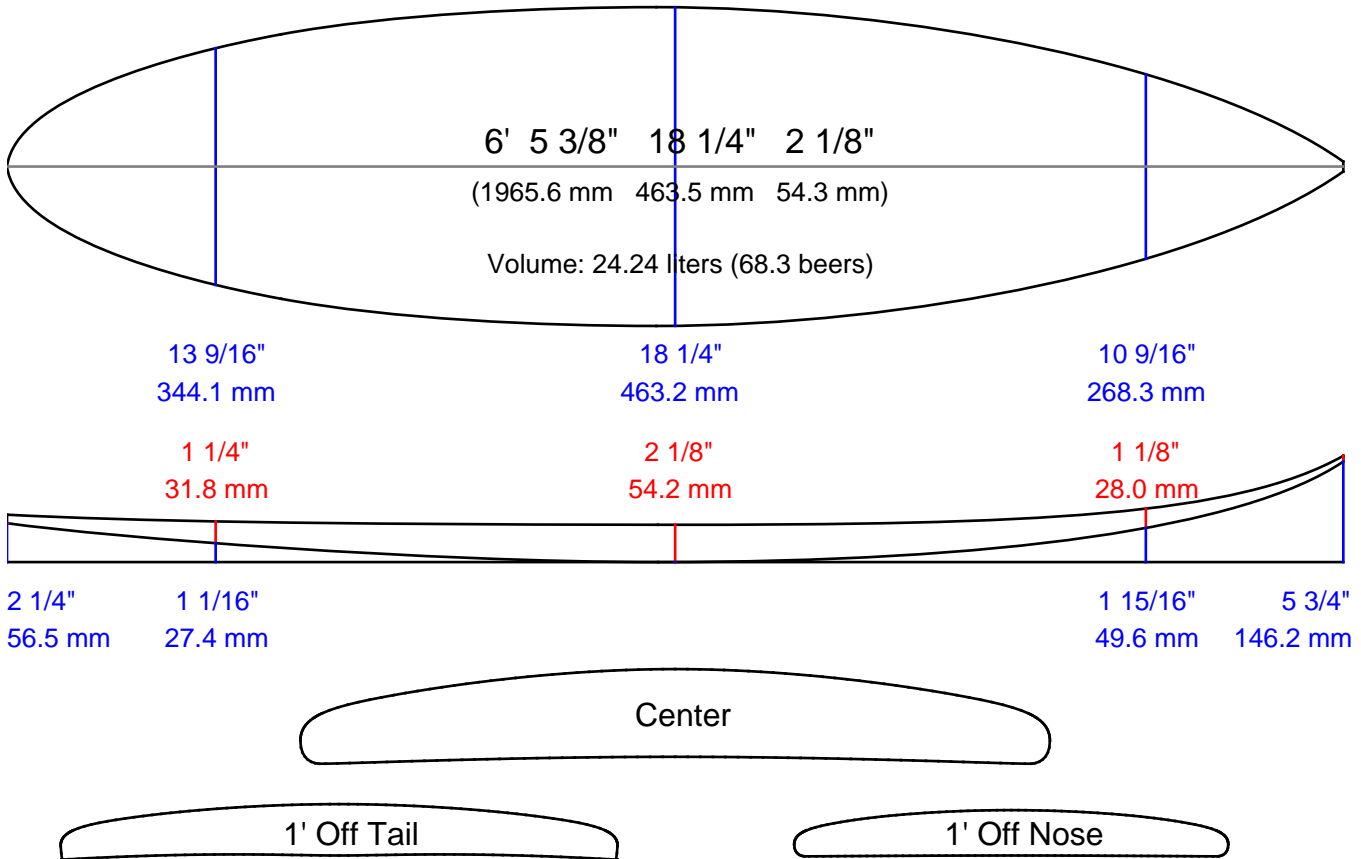

Measurements are center, one foot in and one foot back, over curve.

### Comments:

Based on Slater MBM from Hawaii 05

Back at 3-3/8

Side at 11-1/2, 1-1/8 off rail, 1/4 tow.



# AKU SHAPER

Customer:

Date: Jan 19, 2010

Length: 6' 10" (2082.8)

Width: 20" (508.0)

Thickness: 2 5/8" (66.0)

Tail Stop: 35 7/16" (900.0)

Designed by: Octopus

File: GoliathShape

Blank:

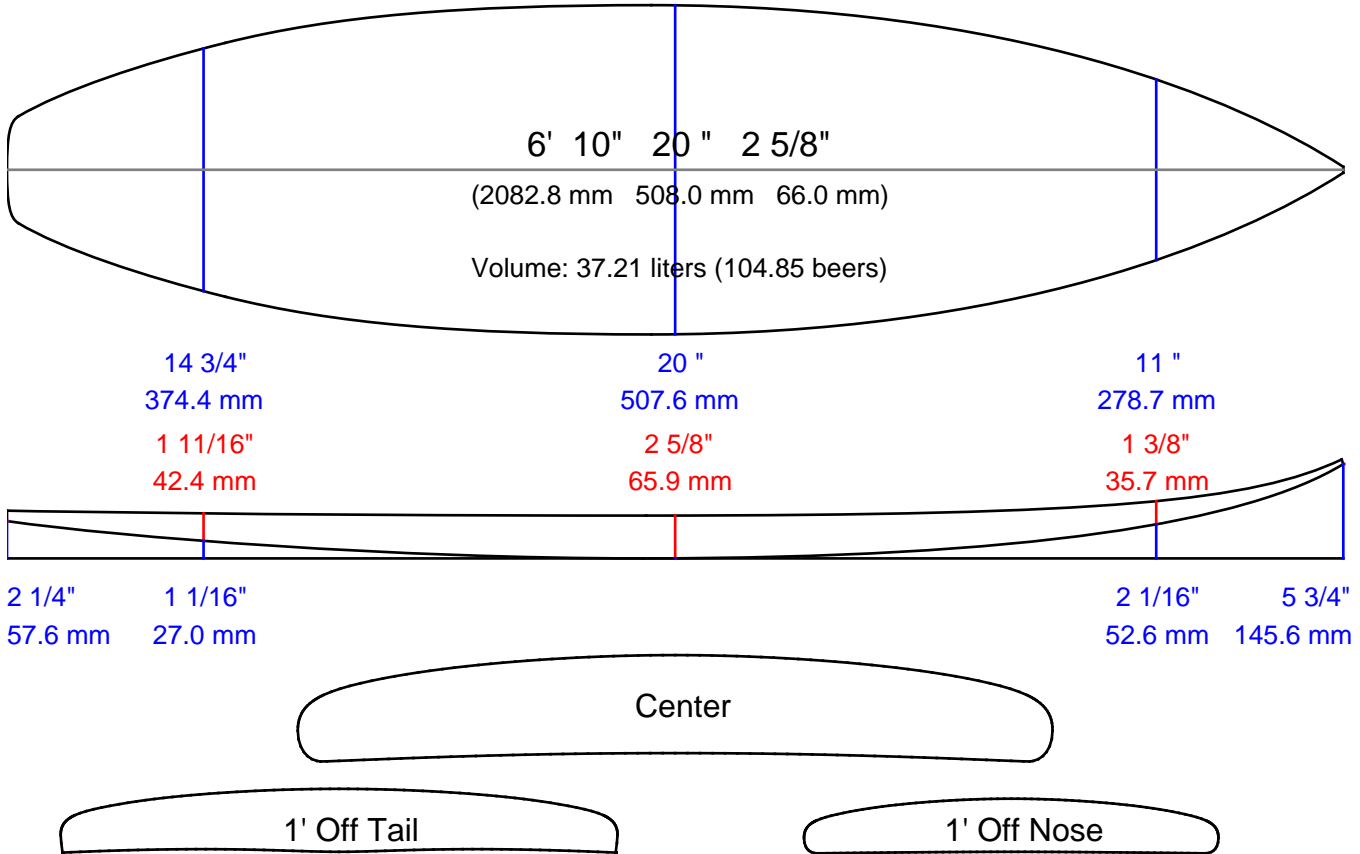

Measurements are center, one foot in and one foot back, over curve.

**Comments:**

Similar to CI Big Boy.

Back fin at 3.5. Front fins at 12, 1.125 off rail, 3/16 tow.



# AKU SHAPER

Customer:

Date: Jan 19, 2010  
Length: 6' 2 3/4" (1899.7)  
Width: 18 5/16" (465.1)  
Thickness: 2 5/16" (58.0)  
Tail Stop: 35 7/16" (900.0)

Designed by: Octopus

File: GWBShape  
Blank:

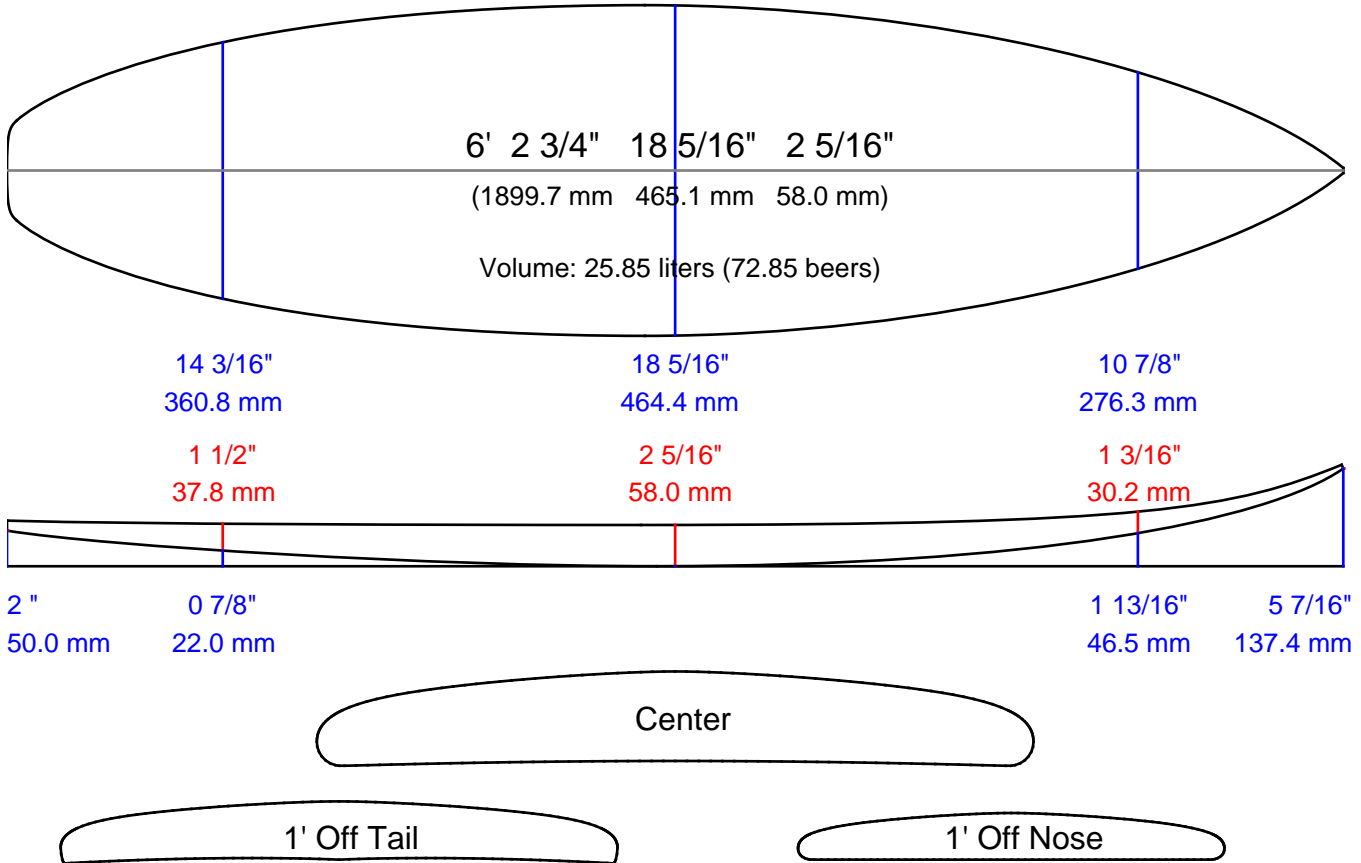

Measurements are center, one foot in and one foot back, over curve.

**Comments:**

Based on CI MBM  
Back fin at 3.5, Side fins at 11.25, 1.125 off rail.



# AKU SHAPER

Customer:

Date:

Jan 19, 2010

Length:

5' 11 1/4" (1810.8)

Width:

18 3/4" (476.3)

Thickness:

2 1/4" (57.8)

Tail Stop:

35 7/16" (900.0)

Designed by: Hopper

File: HippyShape3

Blank:

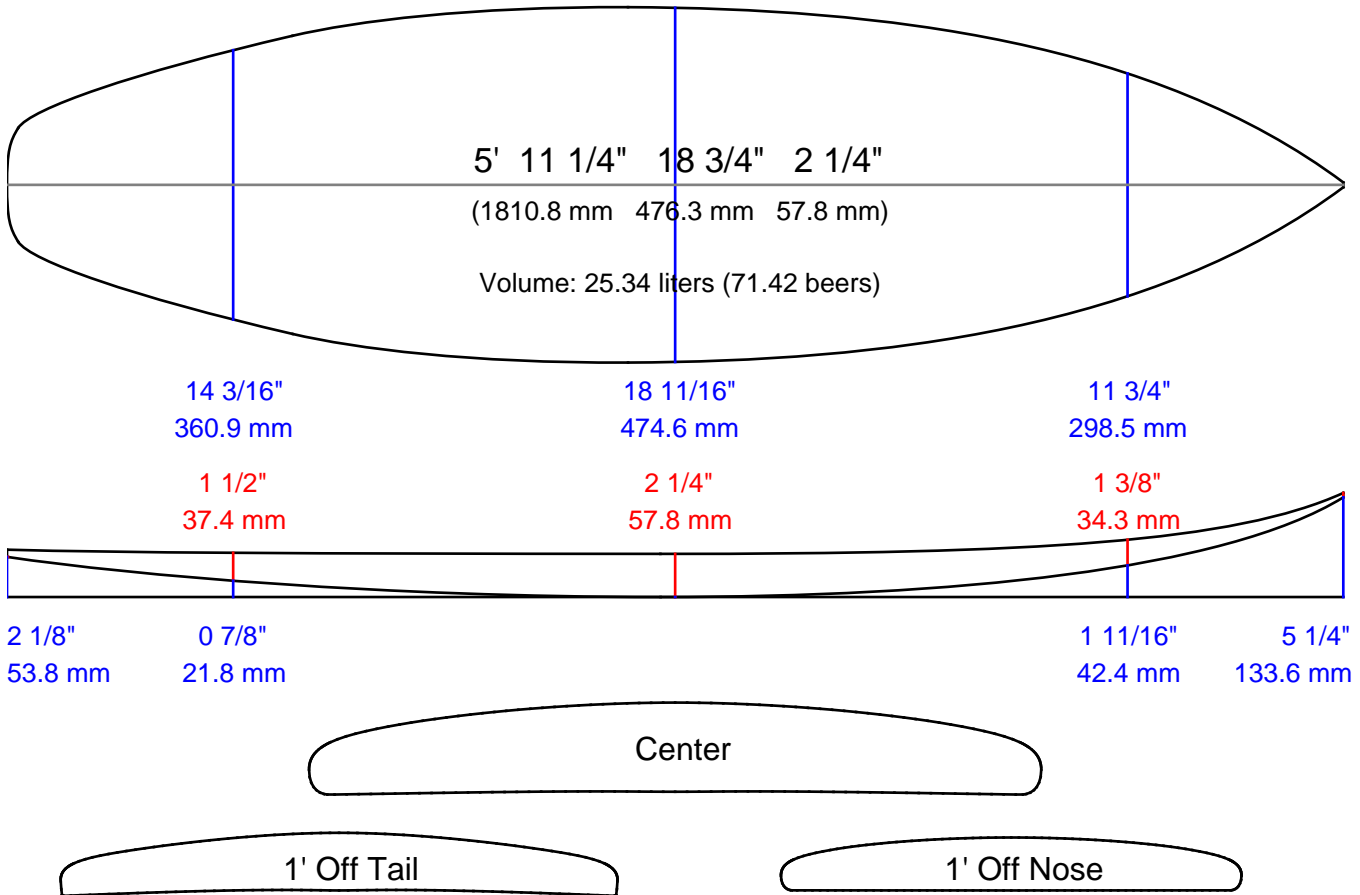

Measurements are center, one foot in and one foot back, over curve.

**Comments:**

Similar to CI Flyer.

Side fin at 10.625, 1.125 off rail, 1/4 tow.

Back fin at 3.25.



# AKU SHAPER

Customer:

Date: Jan 20, 2010

Length: 6' 0 5/8" (1846.2)

Width: 18 5/16" (464.8)

Thickness: 2 3/16" (55.1)

Tail Stop: 0" (0.0)

Designed by:

File: IguanaShape2

Blank:

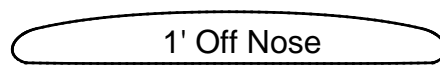
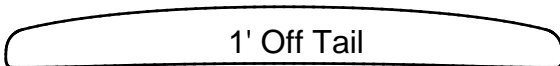
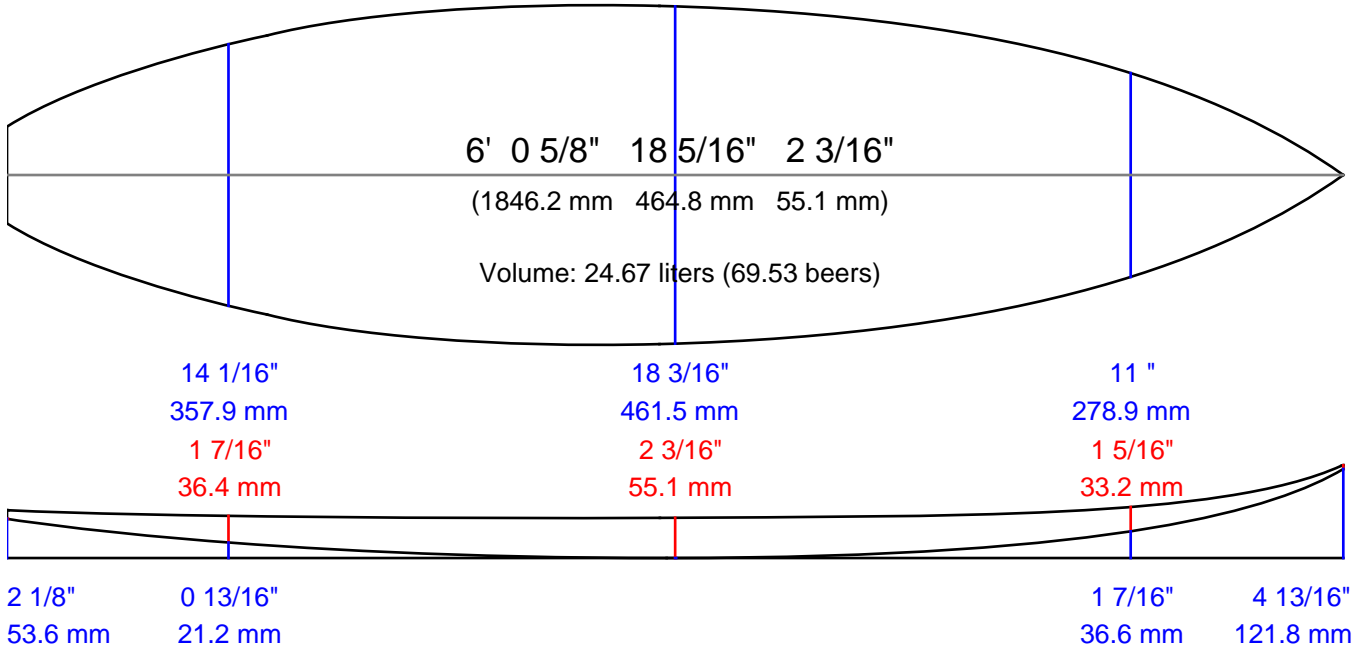

Measurements are center, one foot in and one foot back, over curve.

**Comments:**

Similar to JC Shane Dorian model.



# AKU SHAPER

Customer:

Date: Jan 19, 2010  
Length: 5' 3 3/4" (1619.7)  
Width: 18 13/16" (477.8)  
Thickness: 2 1/16" (52.4)  
Tail Stop: 35 7/16" (900.0)

Designed by: Octopus

File: MagicianShape  
Blank:

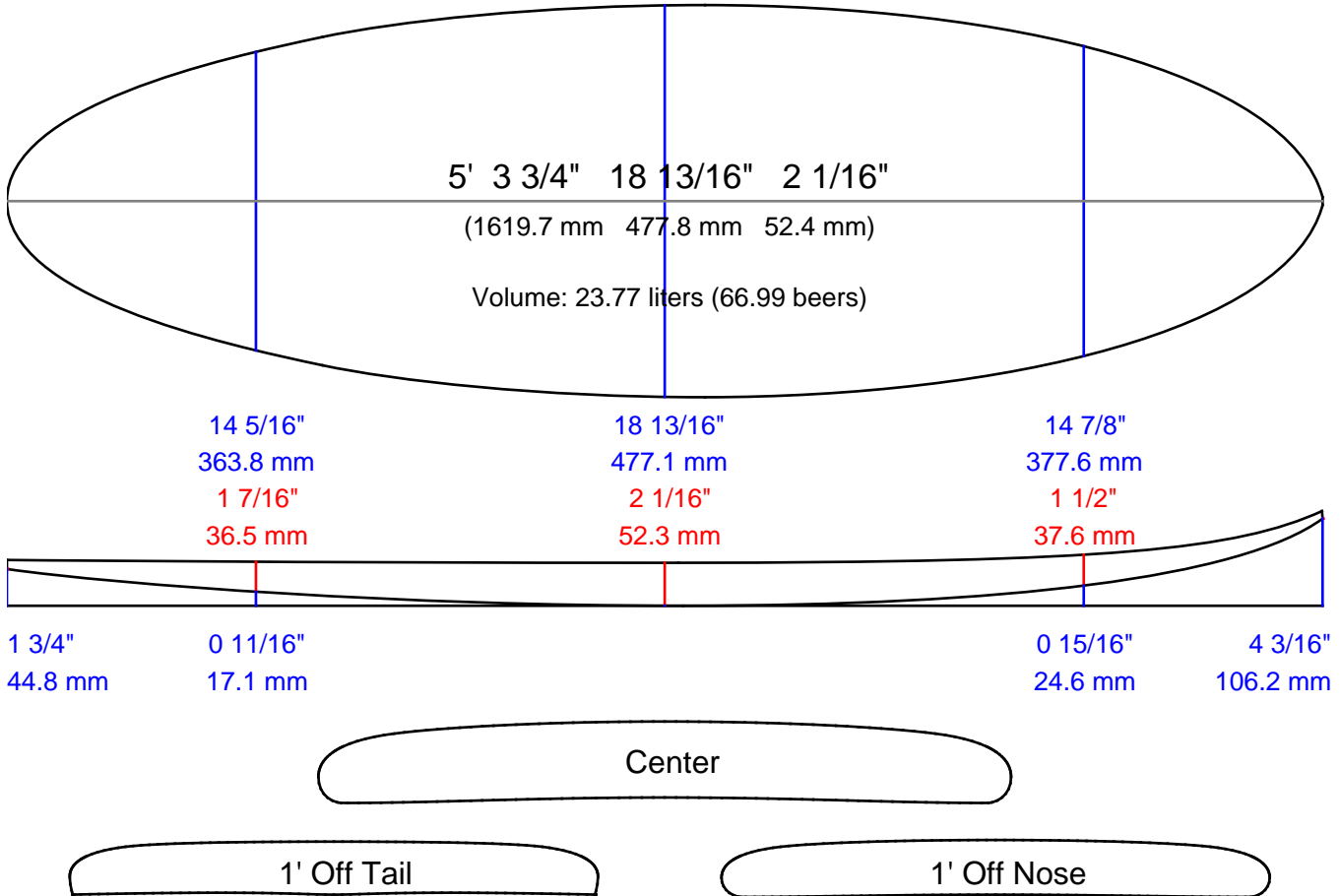

Measurements are center, one foot in and one foot back, over curve.

### Comments:

Similar to CI Slater Wizard Model  
Five fin. Front fins at 10-7/8 off tail and 1.25 off rail, 1/4 tow. Back fins at 5 off tail and 2.125 off rail, 1/16 tow. Back fin at 3.25. Center slice could have up to 0.16 single concave.



# AKU SHAPER

Customer:  
 Date: Jan 19, 2010  
 Length: 6' 4 3/4" (1949.2)  
 Width: 19 5/16" (490.7)  
 Thickness: 2 5/16" (58.2)  
 Tail Stop: 0" (0.0)

Designed by: File: MellowShape2  
 Blank:

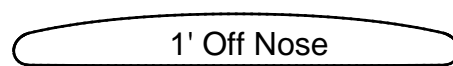
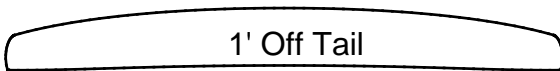
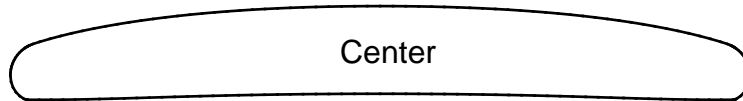
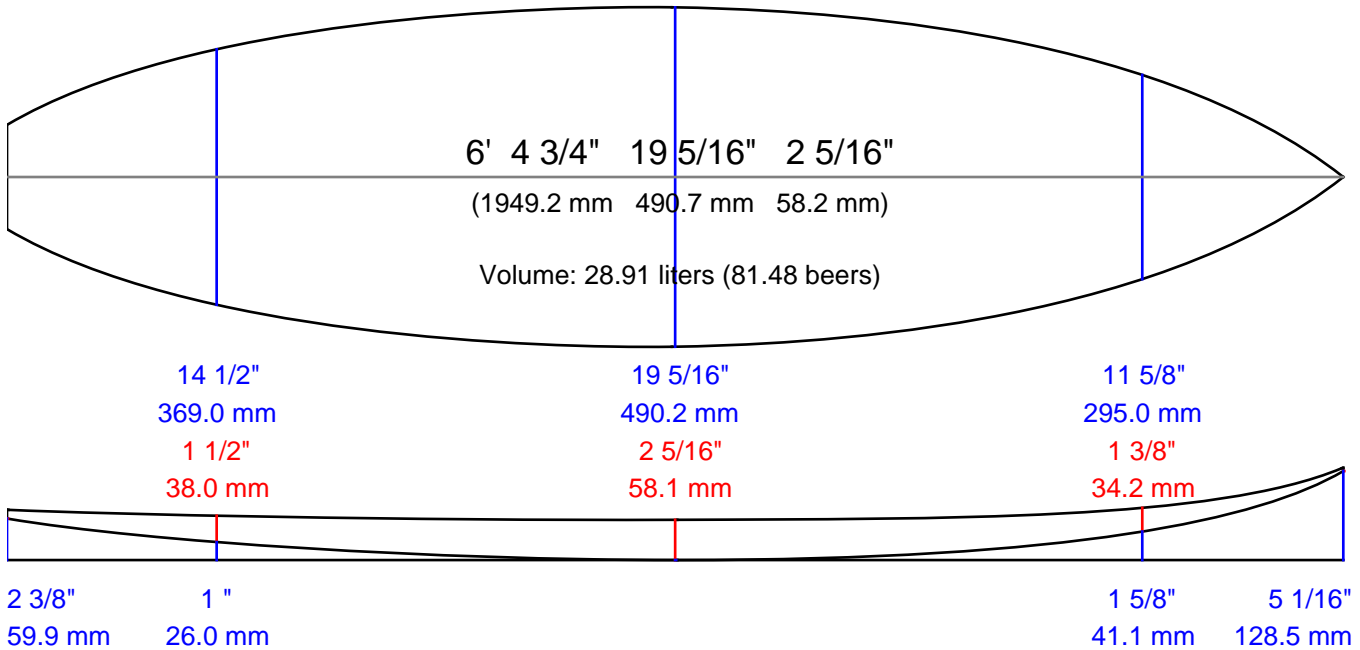

Measurements are center, one foot in and one foot back, over curve.

### Comments:

Similar to JC Peter Mel Model.



# AKU SHAPER

Customer:

Date: Jan 19, 2010  
Length: 5' 11 1/4" (1810.8)  
Width: 19 1/2" (495.3)  
Thickness: 2 1/4" (57.8)  
Tail Stop: 35 7/16" (900.0)

Designed by: Hopper

File: MissileShape  
Blank:

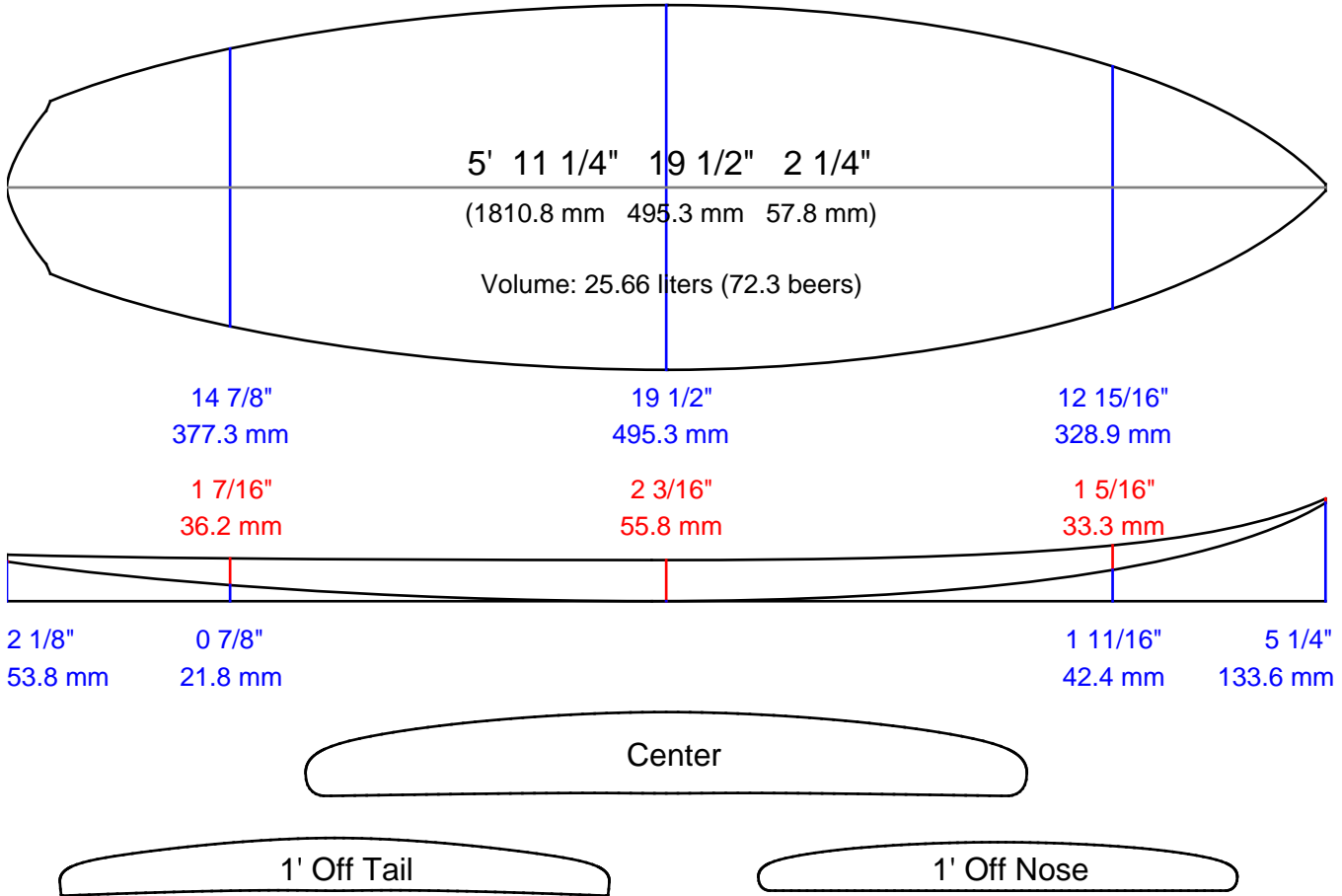

Measurements are center, one foot in and one foot back, over curve.

**Comments:**

- Similar to LOST Rocket.
- Recommended as a 5 fin.
- Front side fins at 10.875, 1.125 off rail, 3/16 tow
- Back side fins at 5.5, 2.25 off rail, 3/16 tow
- Back fin at 3.25.



# AKU SHAPER

Customer:

Date:

Jan 25, 2010

Length:

6' 0 3/4" (1848.9)

Width:

18 1/8" (461.0)

Thickness:

2 1/8" (54.6)

Tail Stop:

0" (0.0)

Designed by:

File: MutantShape

Blank:

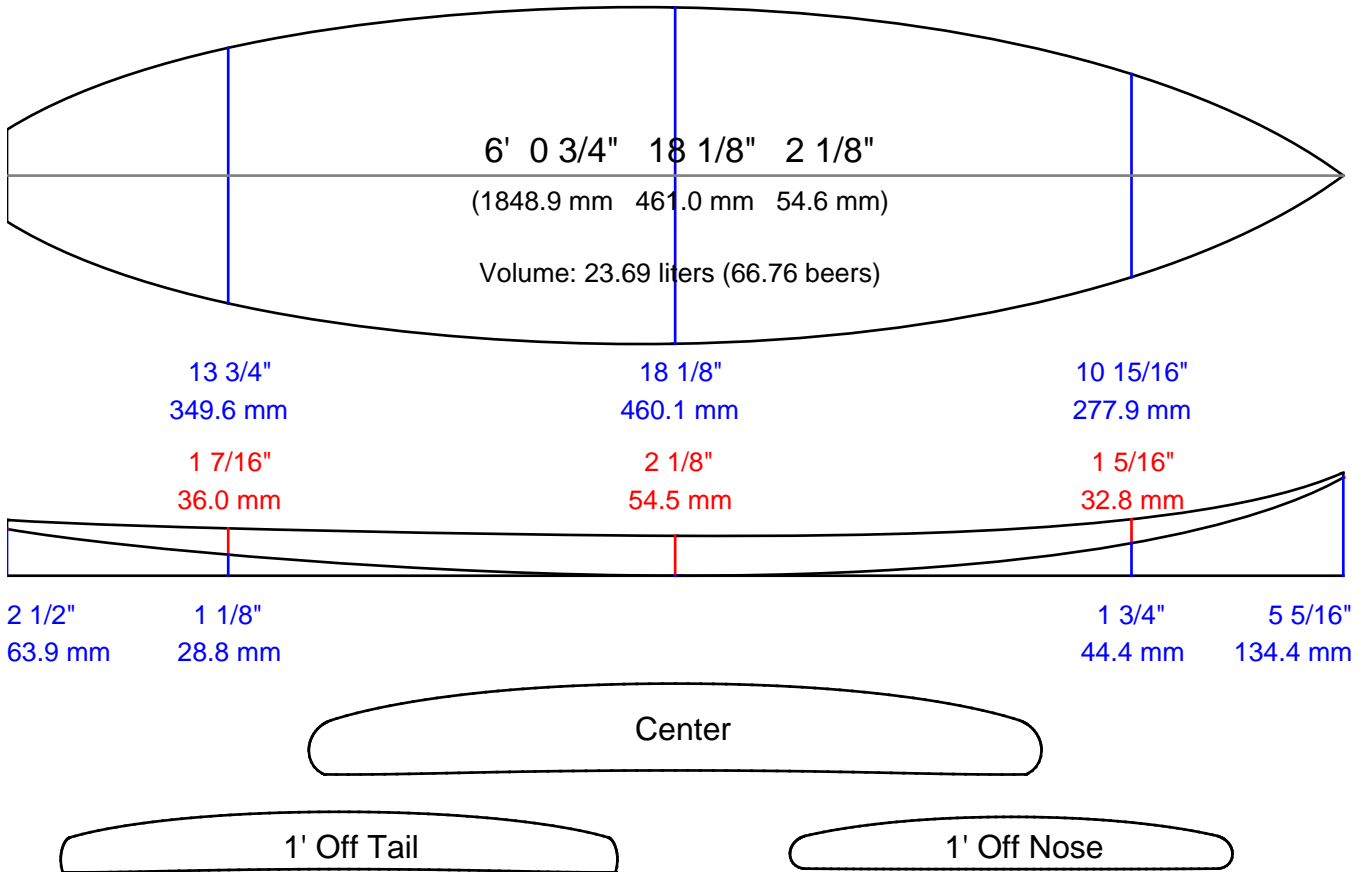

Measurements are center, one foot in and one foot back, over curve.

### Comments:

Similar to JC Sean Moody model.



# AKU SHAPER

Customer:

Date: Jan 19, 2010

Length: 6' 0 3/4" (1848.3)

Width: 18 7/8" (478.8)

Thickness: 2 1/4" (57.2)

Tail Stop: 0" (0.0)

Designed by:

File: NeXtShape2

Blank:

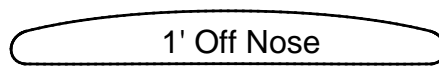
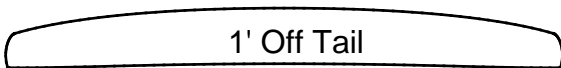
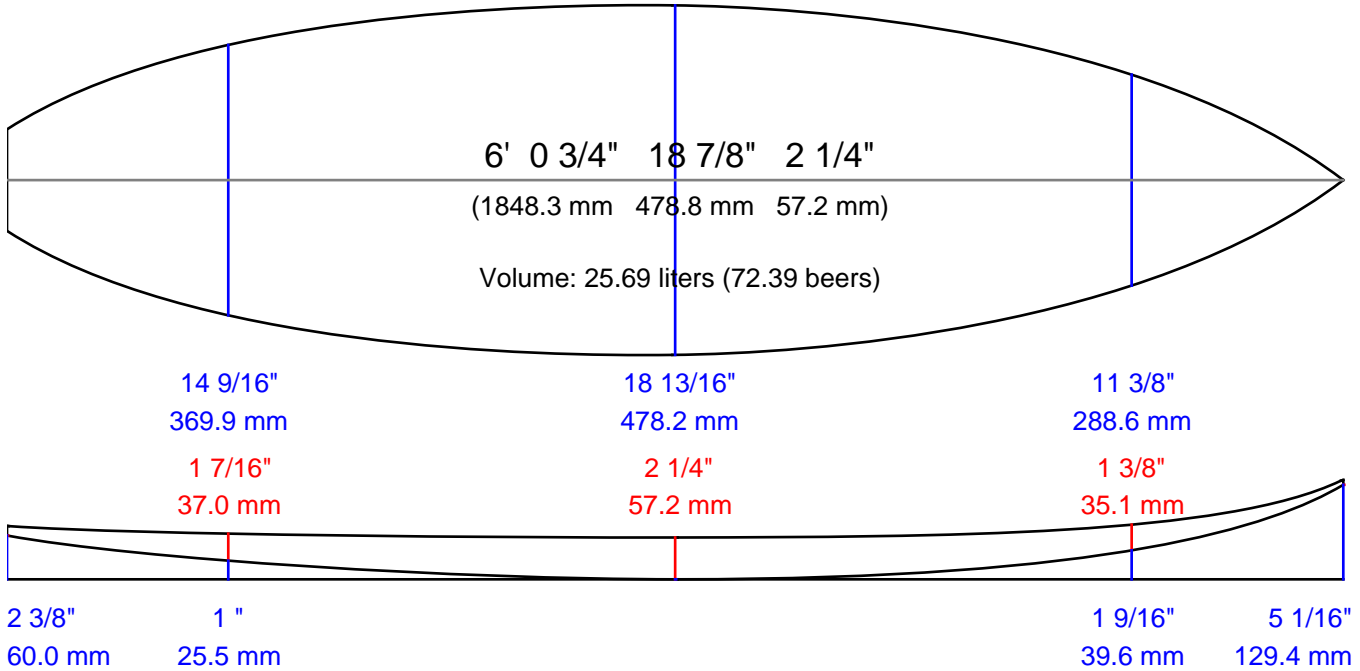

Measurements are center, one foot in and one foot back, over curve.

**Comments:**

Similar to JC NX model.



# AKU SHAPER

Customer:

Date: Jan 19, 2010

Length: 5' 10" (1778.0)

Width: 18 3/4" (476.2)

Thickness: 2 1/4" (56.7)

Tail Stop: 35 7/16" (900.0)

Designed by: Octopus

File: QuatroThumb

Blank:

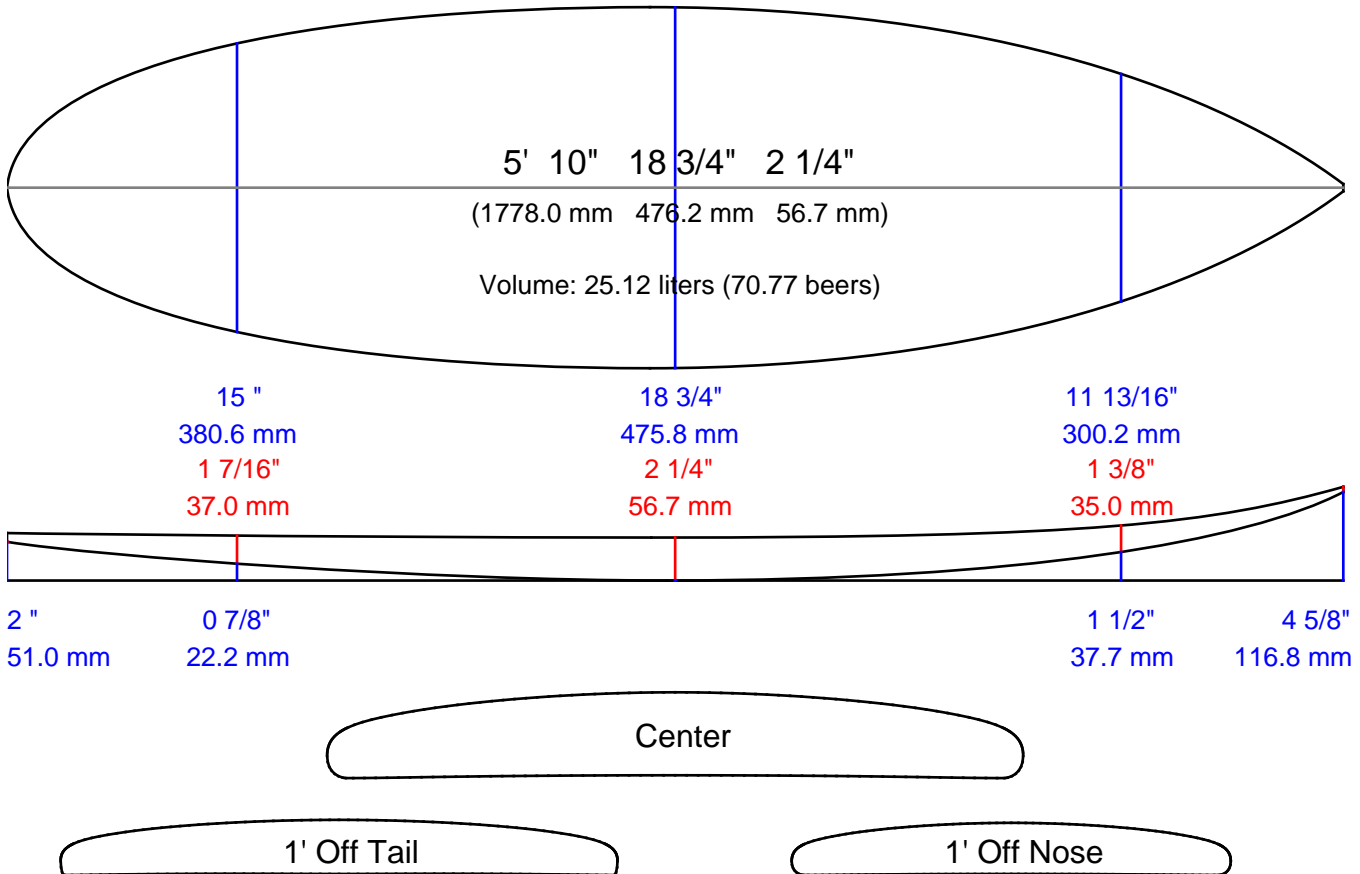

Measurements are center, one foot in and one foot back, over curve.

### Comments:

Similar to Stretch Round Tail Quad.

Quad. Side at 5.5 and 2.25 off rail. Side 2 at 11 and 1.25 off rail. Tow all fins to noze.

Front fins have cant.

Back fins NO CANT.

Also available with a BAT tail.



# AKU SHAPER

Customer:

Date: Jan 19, 2010

Length: 7' 2" (2184.5)

Width: 19 3/8" (492.1)

Thickness: 2 7/8" (72.3)

Tail Stop: 35 7/16" (900.0)

Designed by: Octopus

File: RoeShape

Blank: U.S. Foam 7'3A+.25TL.Rkr

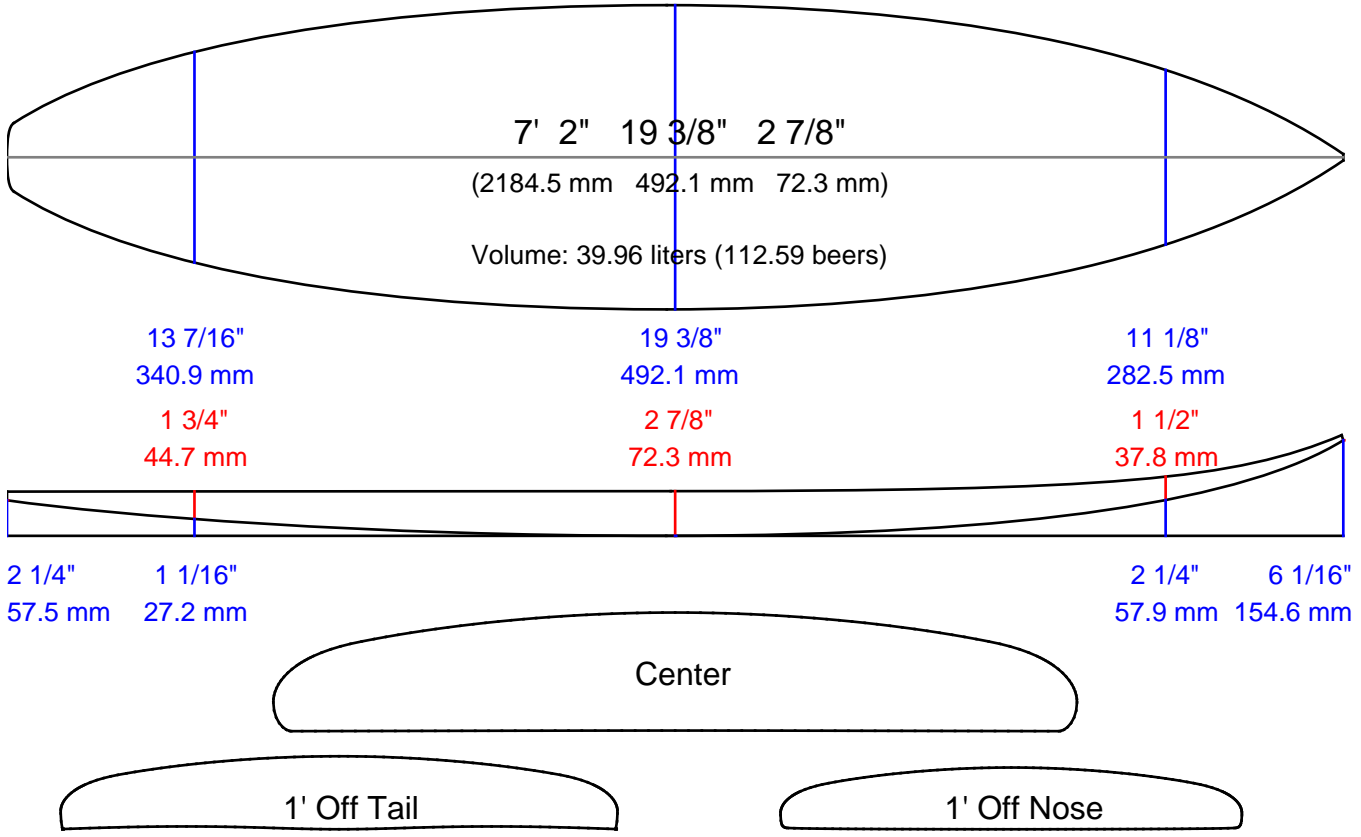

Measurements are center, one foot in and one foot back, over curve.

**Comments:**

ORIGINAL. Back fin at 4. Side fins at 11.75 and 1.375 off rail with 3/16 tow.



# AKU SHAPER

Customer:

Date: Jan 19, 2010  
Length: 5' 11 1/4" (1810.8)  
Width: 18 3/4" (476.3)  
Thickness: 2 1/4" (57.8)  
Tail Stop: 35 7/16" (900.0)

Designed by: Octopus

File: StealthShape  
Blank:

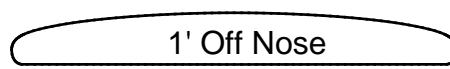
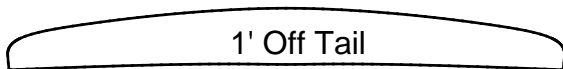
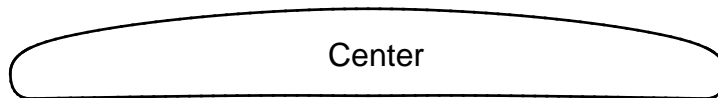
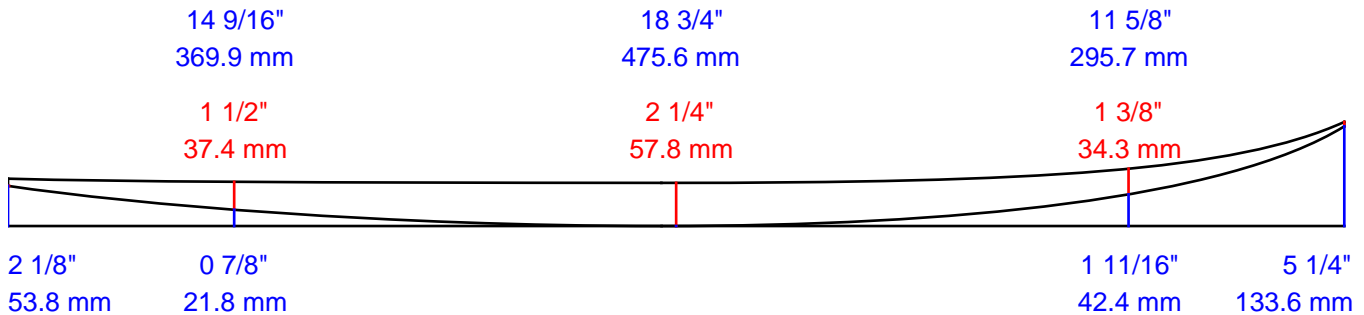
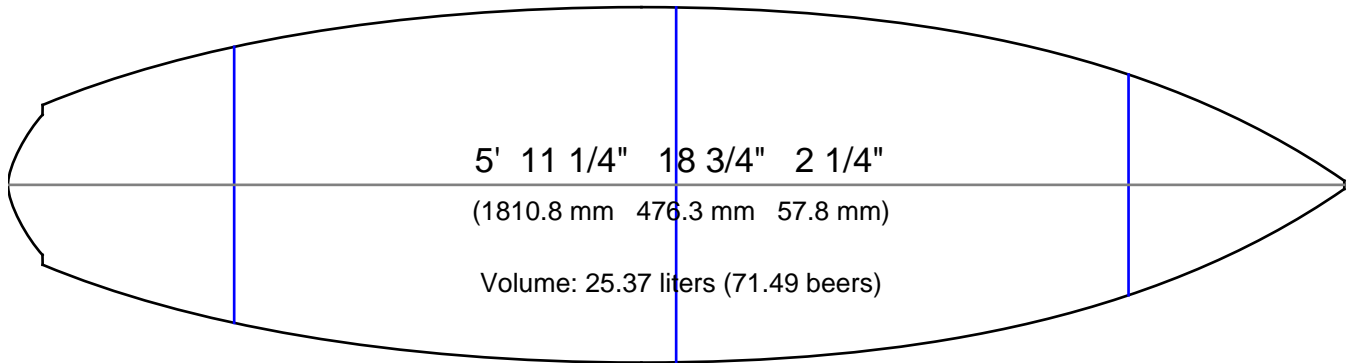

Measurements are center, one foot in and one foot back, over curve.

**Comments:**

Similar to LOST Stealth.  
Recommended as a 5 fin.  
Front side fins at 10.875, 1.125 off rail, 3/16 tow  
Back side fins at 5.5, 2.25 off rail, 3/16 tow  
Back fin at 3.25.



# AKU SHAPER

Customer:

Date: Jan 19, 2010

Length: 6' 2 5/8" (1896.5)

Width: 18 3/4" (476.3)

Thickness: 2 3/16" (56.1)

Tail Stop: 35 7/16" (900.0)

Designed by: Octopus

File: WombatShape

Blank:

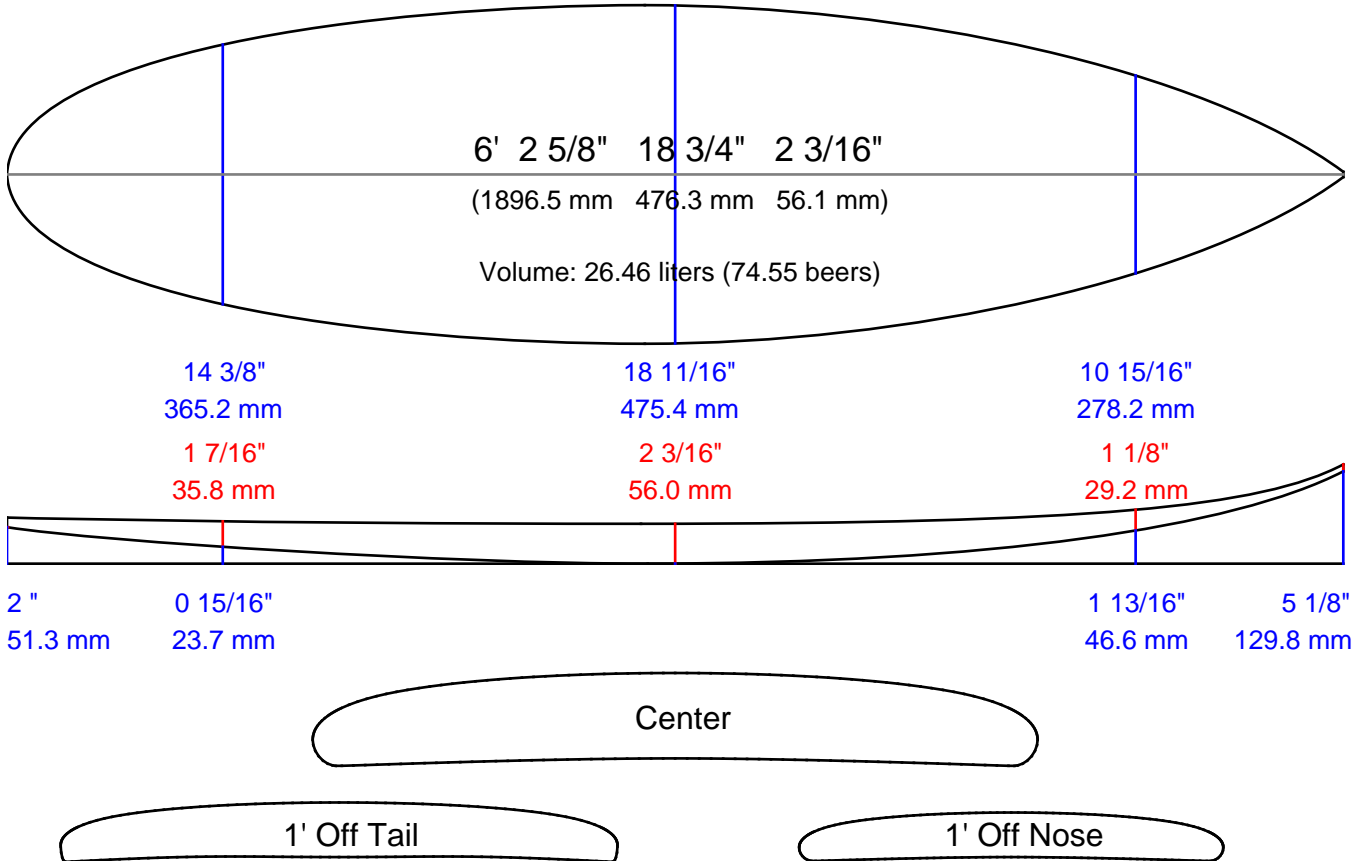

Measurements are center, one foot in and one foot back, over curve.

**Comments:**

Similar to JS Combat.

Back fin at 3 5/16. Side fins at 11 1/16, 1.25 off rail, 3/16 tow.