



# AKU SHAPER

Customer:

Date: Jan 20, 2010  
Length: 9' 6 3/8" (2906.2)  
Width: 22 1/4" (564.9)  
Thickness: 2 15/16" (74.0)  
Tail Stop: 23 5/8" (600.0)

Designed by: Octopus

File: ClassicShape  
Blank:

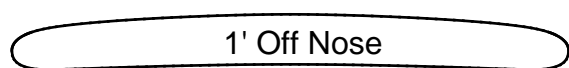
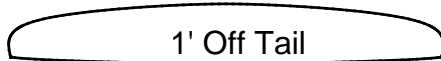
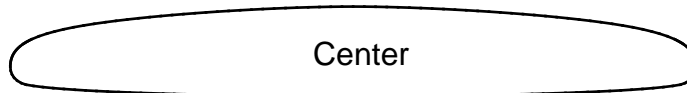
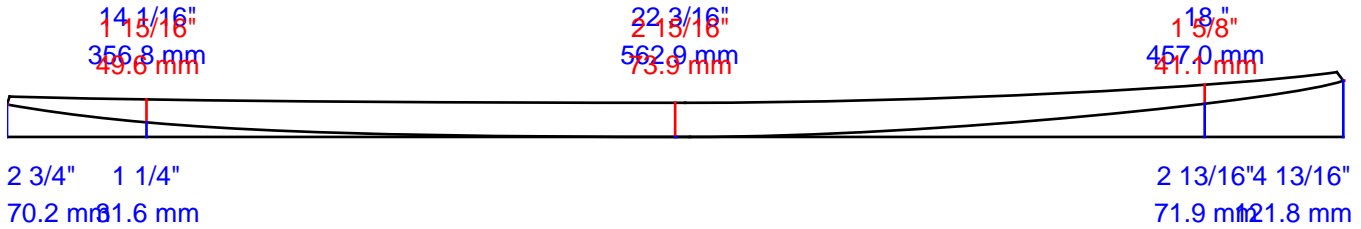
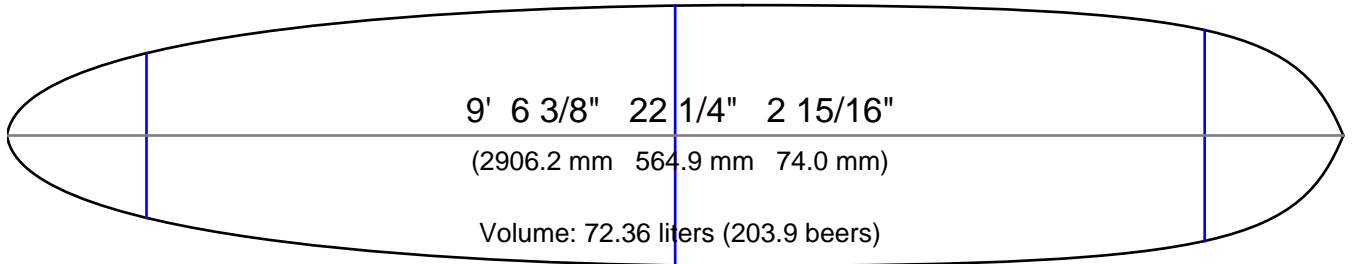

Measurements are center, one foot in and one foot back, over curve.

**Comments:**

ORIGINAL. Similar to custom Takayama single fin beast.



# AKU SHAPER

Customer:

Date: Jan 20, 2010  
Length: 7' 11 1/2" (2426.8)  
Width: 21" (533.4)  
Thickness: 2 5/8" (67.0)  
Tail Stop: 23 5/8" (600.0)

Designed by: Octopus

File: DivertidoShape  
Blank:

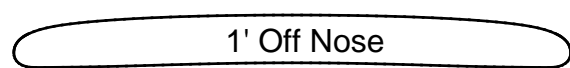
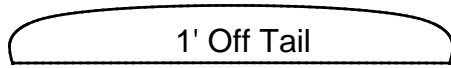
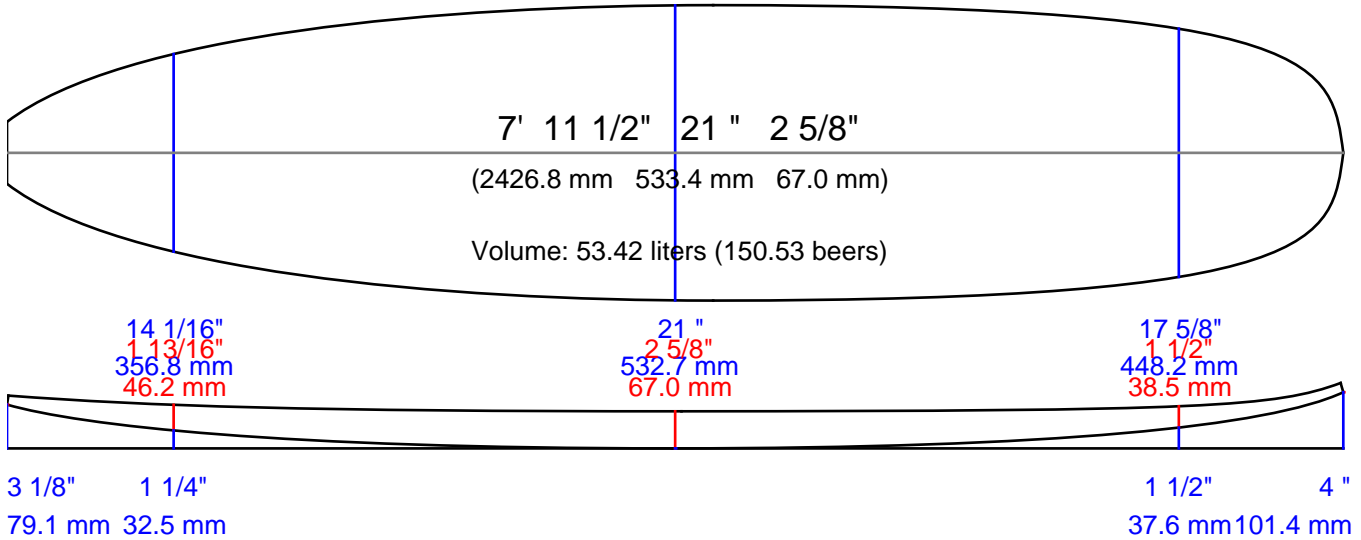

Measurements are center, one foot in and one foot back, over curve.

**Comments:**

Similar to custom McTavish.

ORIGINAL - Optional 1/8 inch deep channel from 18" off the nose to 42" off, 12" Wide. Side fins at 14 and 1.25 off. Back fin box at 4 inches.



# AKU SHAPER

Customer:

Date: Jan 20, 2010

Length: 9' 0 1/2" (2757.3)

Width: 22 " (558.8)

Thickness: 2 7/8" (72.8)

Tail Stop: 23 5/8" (600.0)

Designed by: Octopus

File: DNAShape

Blank:

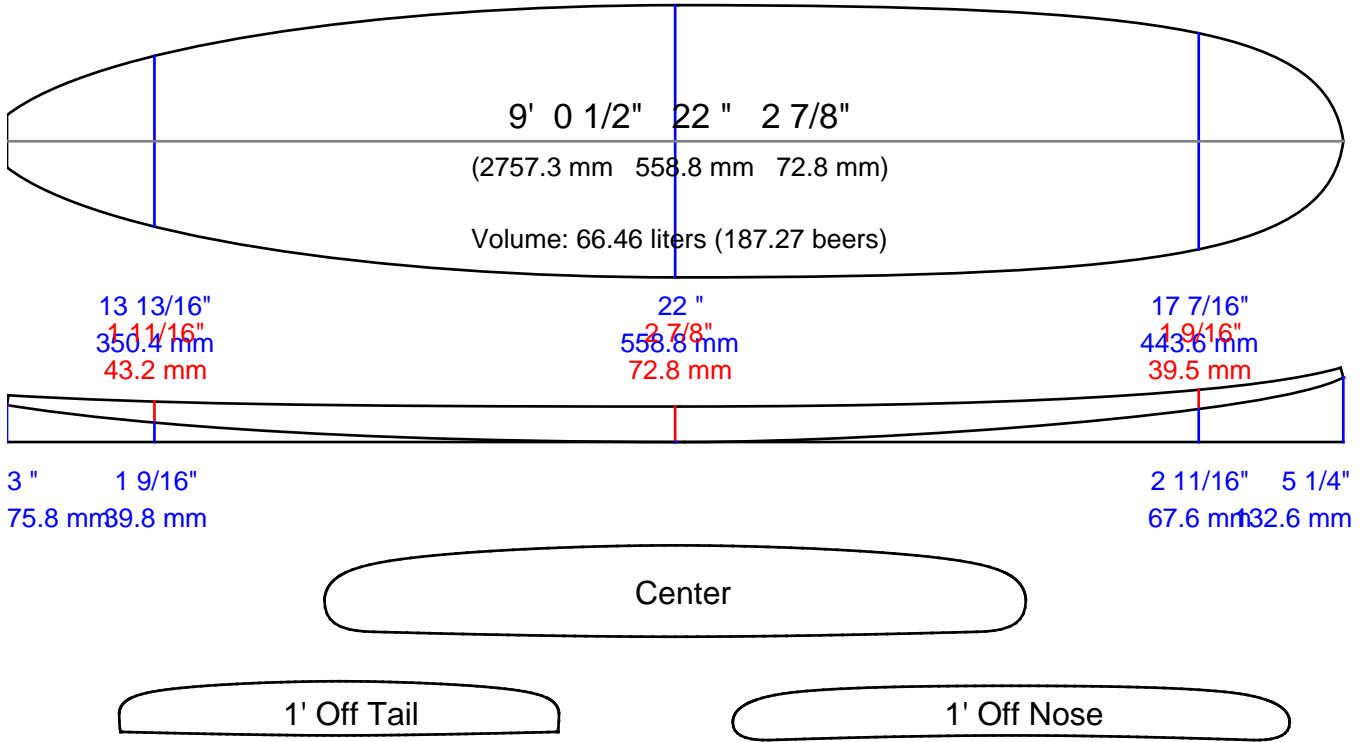

Measurements are center, one foot in and one foot back, over curve.

### Comments:

Similar to custom Ukulele model.

ORIGINAL Side fins at 15-5/8, 1 inch off rail. Back fin box at 4.



# AKU SHAPER

Customer:

Date: Jan 20, 2010

Length: 7' 4 3/4" (2254.3)

Width: 20 3/4" (527.1)

Thickness: 2 5/8" (66.4)

Tail Stop: 23 5/8" (600.0)

Designed by: Octopus

File: GatorShape

Blank:

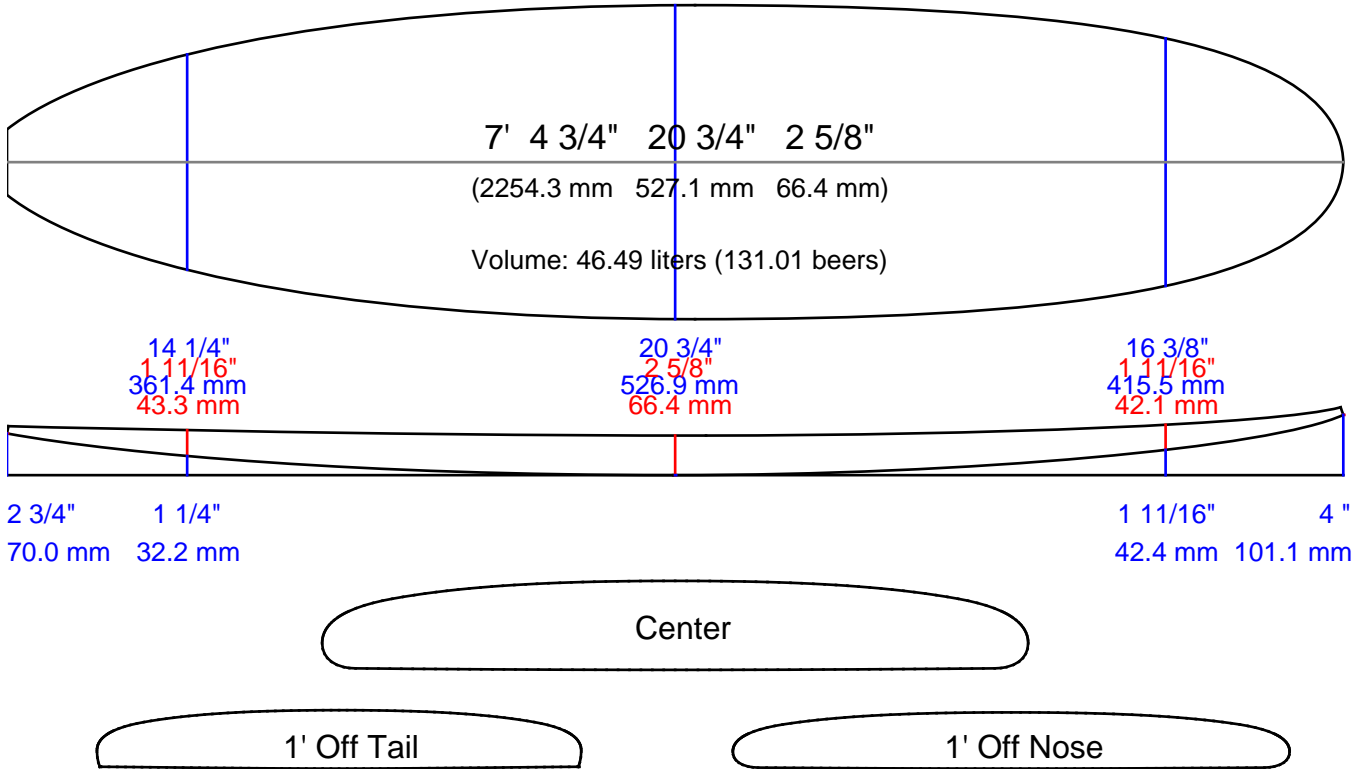

Measurements are center, one foot in and one foot back, over curve.

**Comments:**

Similar to Yater custom fun board.

ORIGINAL. Back fin at 4. Side fins at 12.5, 1-7/16 off rail, 3/16 tow.



# AKU SHAPER

Customer:

Date: Jan 20, 2010

Length: 9' 1 1/2" (2779.8)

Width: 22 " (558.1)

Thickness: 3 1/8" (79.2)

Tail Stop: 23 5/8" (600.0)

Designed by: Octopus

File: GramplinShape

Blank:

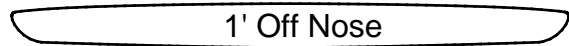
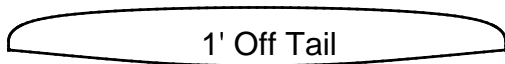
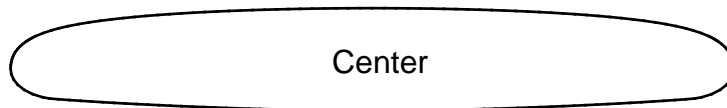
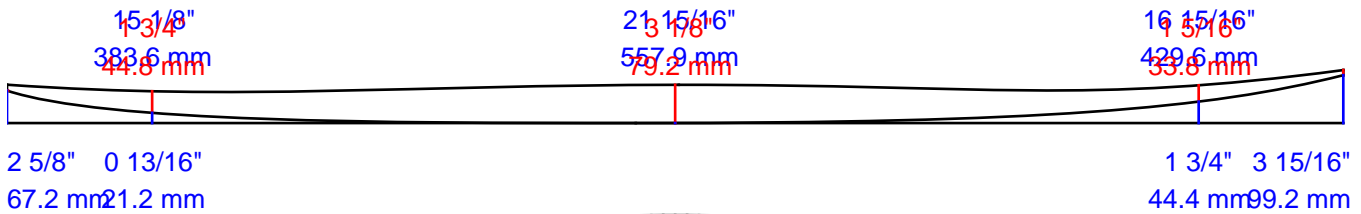
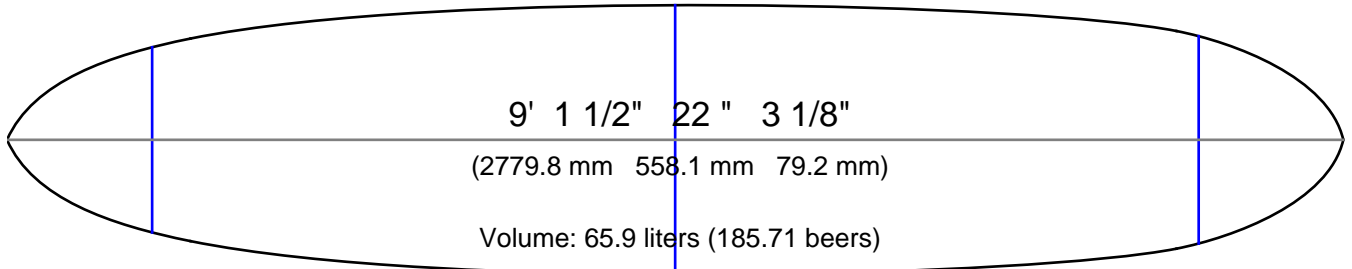

Measurements are center, one foot in and one foot back, over curve.

**Comments:**

Similar to BOSS traditional step deck log.  
Single fin.



# AKU SHAPER

Customer:

Date: Jan 20, 2010

Length: 9' 4 1/2" (2857.4)

Width: 23 " (584.8)

Thickness: 2 9/16" (64.5)

Tail Stop: 23 5/8" (600.0)

Designed by: Octopus

File: MoonShape

Blank:

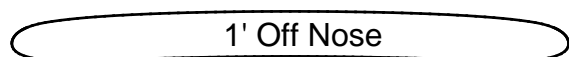
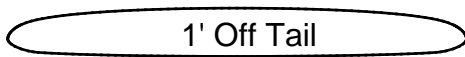
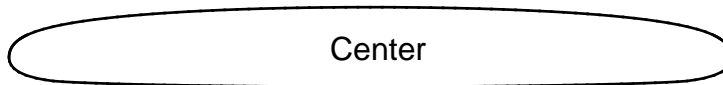
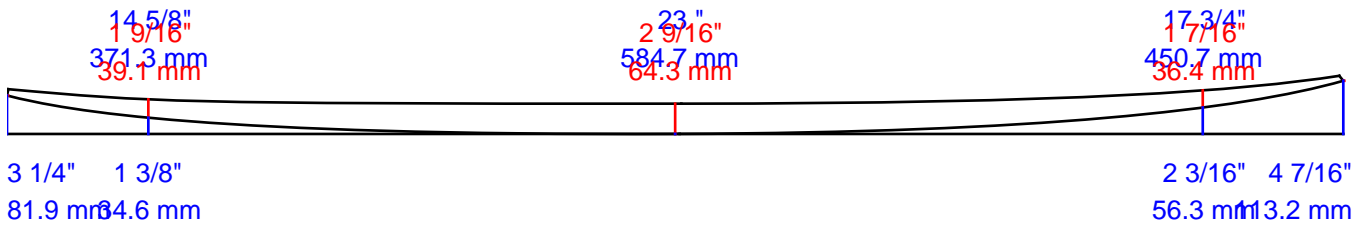
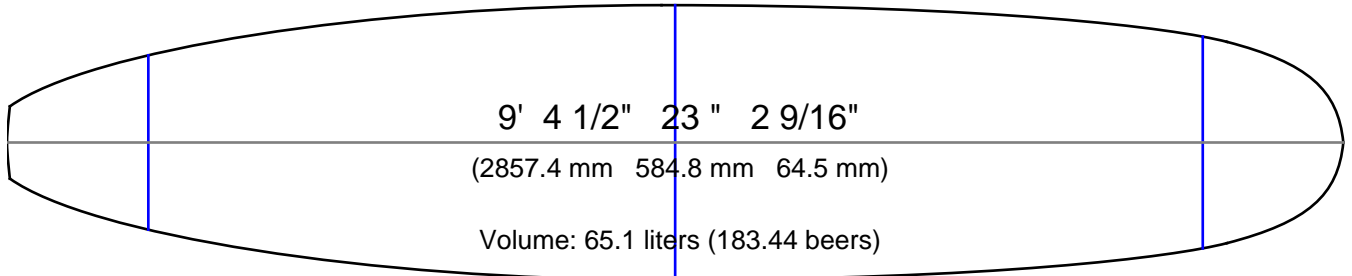

Measurements are center, one foot in and one foot back, over curve.

**Comments:**

Similar to custom Munoz model.

ORIGINAL. Single fin.



# AKU SHAPER

Customer:

Date: Jan 20, 2010  
Length: 8' 10 3/4" (2711.5)  
Width: 21 3/8" (542.6)  
Thickness: 2 5/8" (66.9)  
Tail Stop: 23 5/8" (600.0)

Designed by: Octopus

File: RATshape  
Blank:

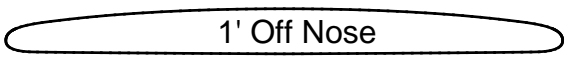
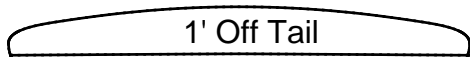
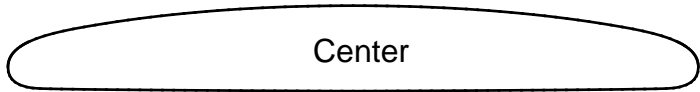
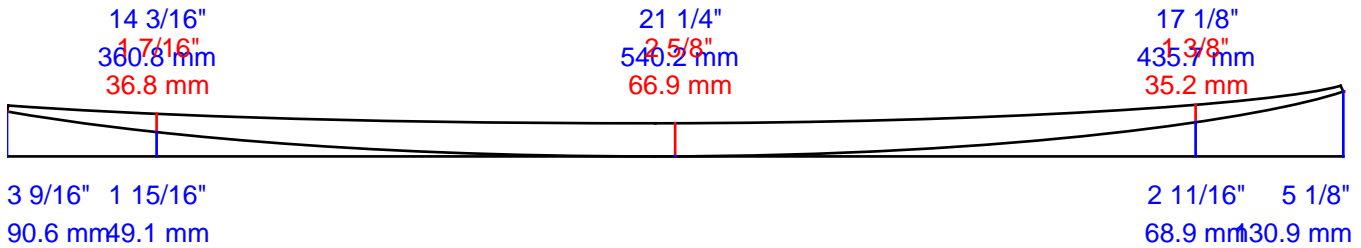
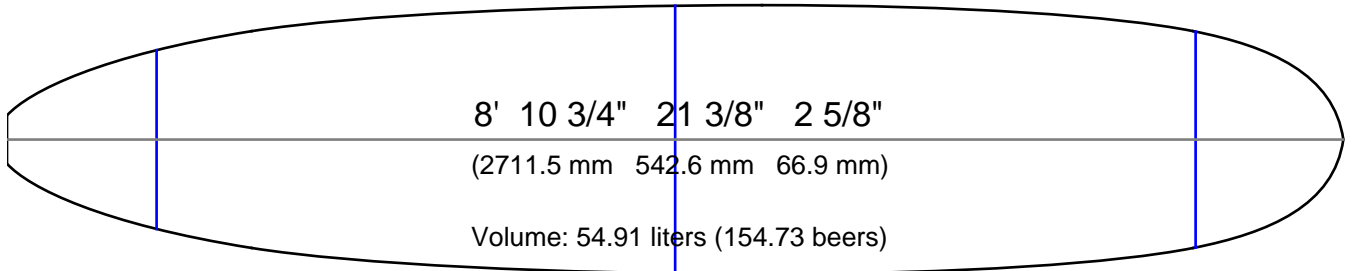

Measurements are center, one foot in and one foot back, over curve.

**Comments:**

Similar to custom Pearson Arrow high performance log.  
ORIGINAL. Back fin box at 6. Side fins at 15.5, 1-3/8 off rail, 1/8 tow.



# AKU SHAPER

Customer:

Date: Jan 20, 2010

Length: 9' 1 5/8" (2784.0)

Width: 22 5/8" (574.7)

Thickness: 2 7/8" (72.8)

Tail Stop: 23 5/8" (600.0)

Designed by: Octopus

File: TacoShape

Blank:

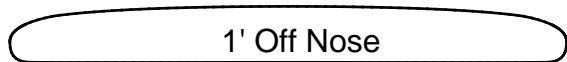
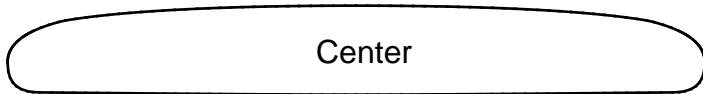
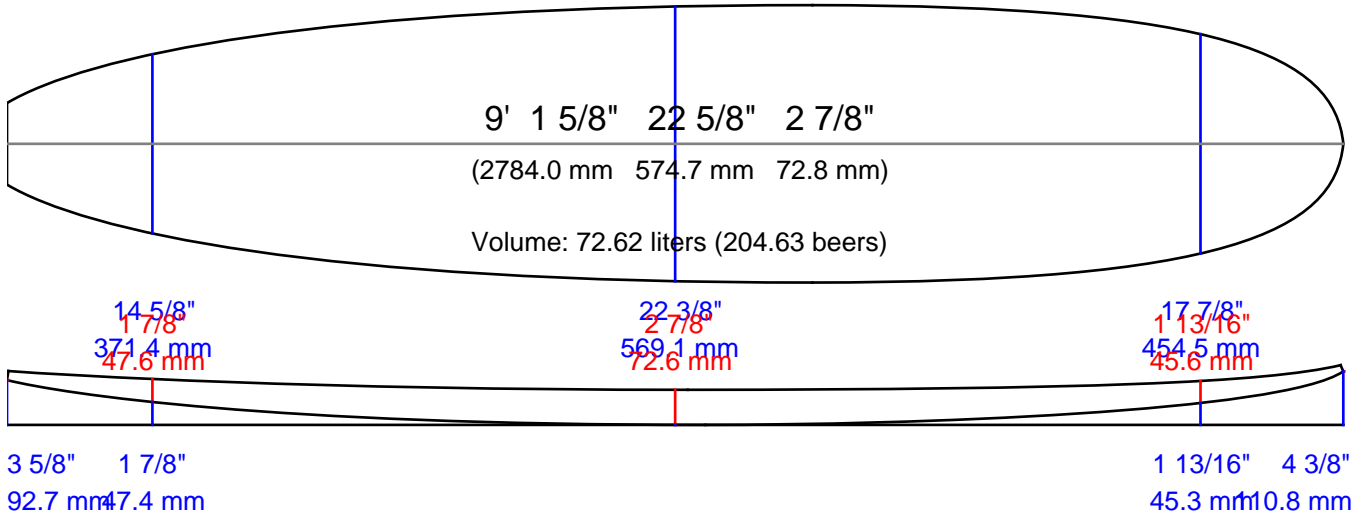

Measurements are center, one foot in and one foot back, over curve.

**Comments:**

Original. Similar to custom Takayama square tail.