



AKU SHAPER

Customer:

Date: Jan 20, 2010
Length: 6' 11 1/2" (2120.3)
Width: 20 1/2" (520.7)
Thickness: 3" (75.9)
Tail Stop: 35 7/16" (900.0)

Designed by: Octopus

File: AipaShape
Blank:

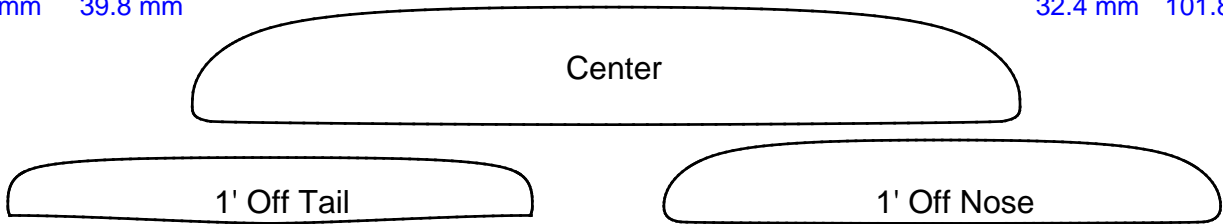
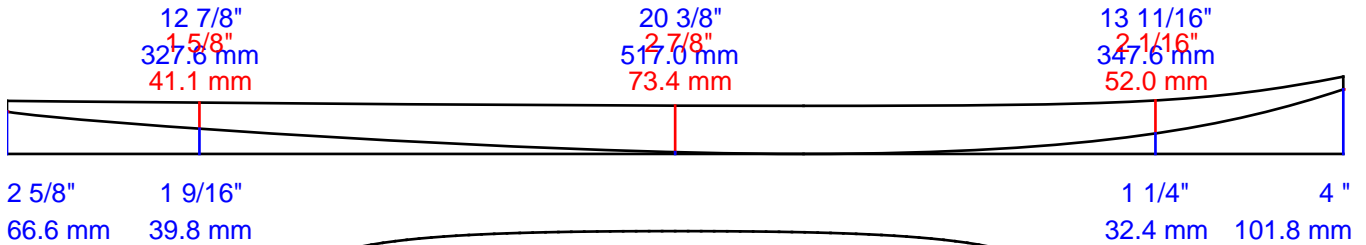
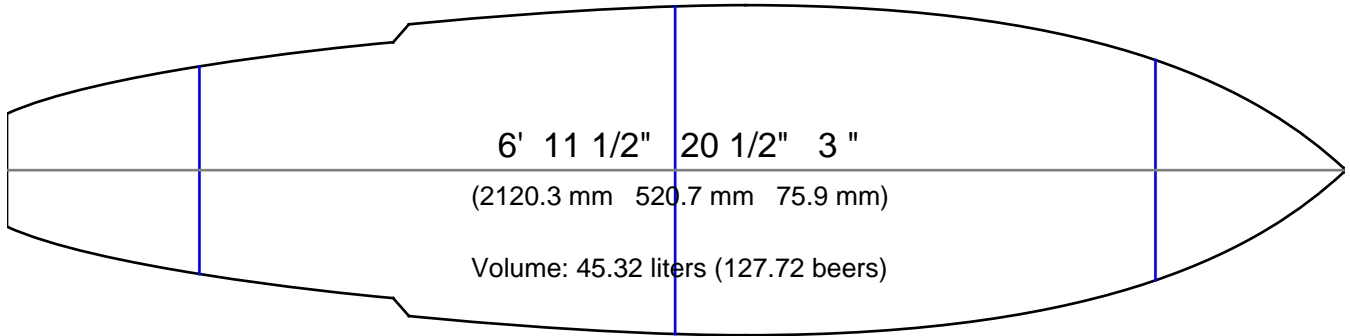

Measurements are center, one foot in and one foot back, over curve.

Comments:

Similar to Aipa Stinger.
ORIGINAL. Single Fin.



AKU SHAPER

Customer:
 Date: Jan 19, 2010
 Length: 7' 0 3/4" (2151.6)
 Width: 22 3/16" (563.9)
 Thickness: 2 13/16" (71.1)
 Tail Stop: 35 7/16" (900.0)

Designed by: Octopus

File: AjoShape
 Blank:

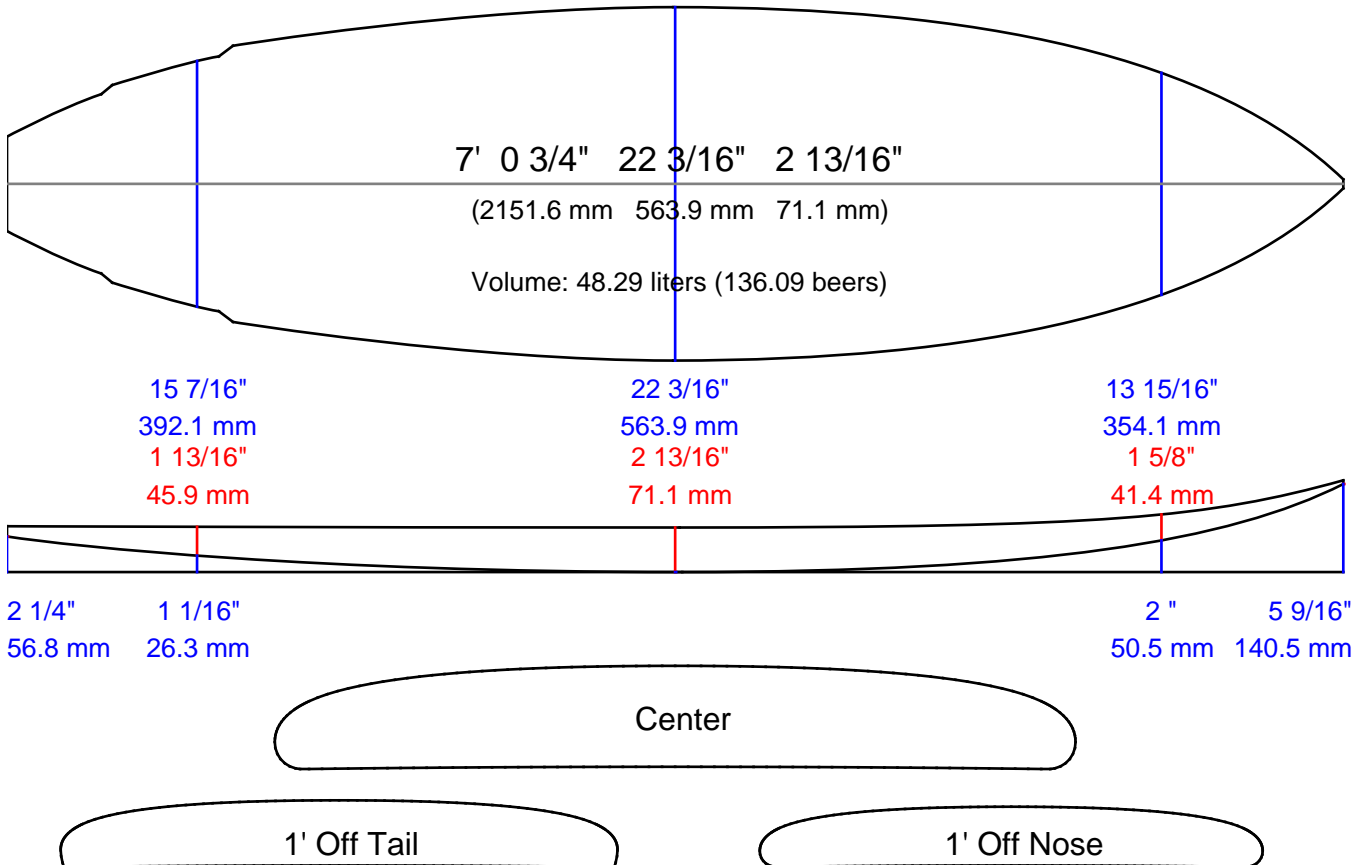

Measurements are center, one foot in and one foot back, over curve.

Comments:

ORIGINAL. Back fin at 4. Side fins at 11.5, 1.25 off rail, 1/4" tow. Original board had a tri-hull, but updated it to all single. Swallow tail.



AKU SHAPER

Customer:

Date: Jan 19, 2010
Length: 5' 10 1/8" (1780.6)
Width: 20 9/16" (522.3)
Thickness: 2 3/4" (69.2)
Tail Stop: 35 7/16" (900.0)

Designed by: Octopus

File: BeetleShape
Blank:

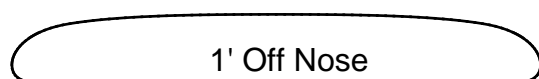
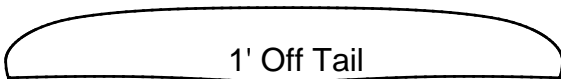
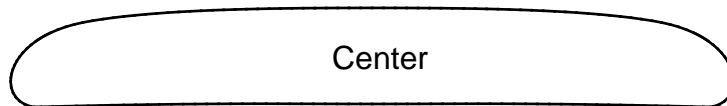
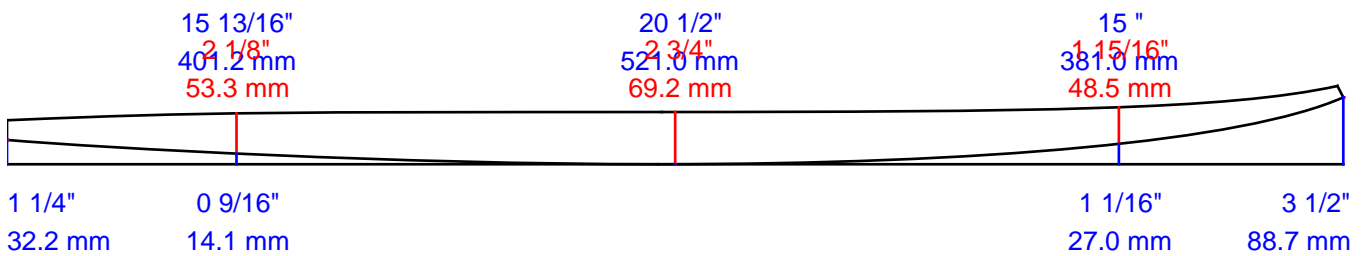
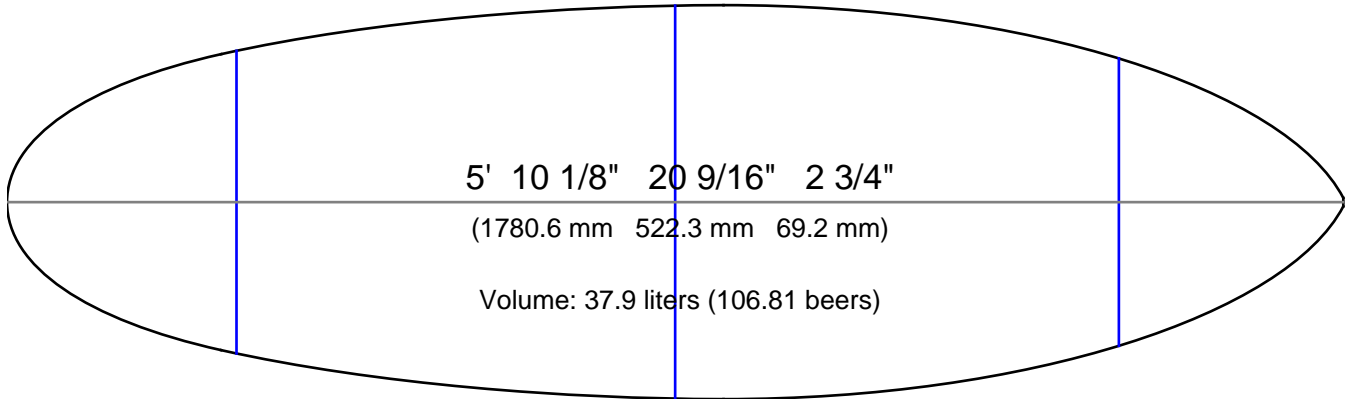

Measurements are center, one foot in and one foot back, over curve.

Comments:

Similar to CI Biscuit.
Back fin 3-7/8
Front fins 10-7/8, 1.25, 1/4 tow.



AKU SHAPER

Customer:

Date: Jan 19, 2010

Length: 5' 9 1/2" (1766.8)

Width: 20" (508.0)

Thickness: 2 1/8" (54.0)

Tail Stop: 35 7/16" (900.0)

Designed by: Octopus

File: BluntWingerShape

Blank:

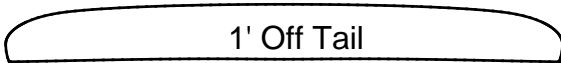
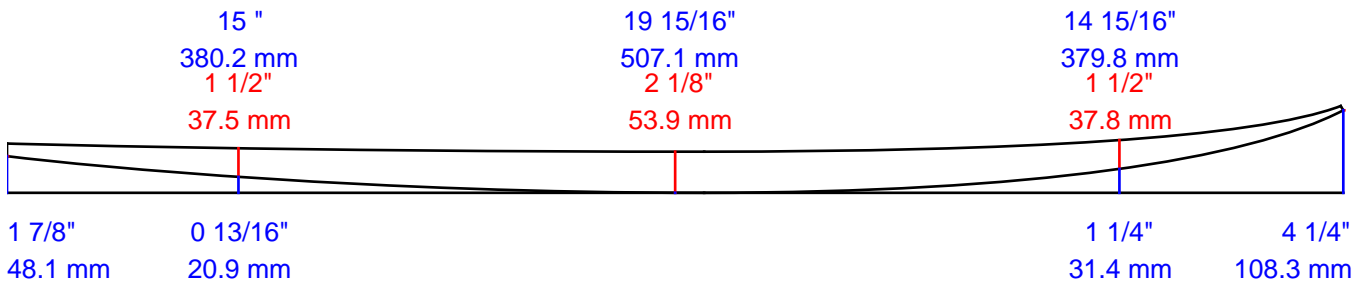
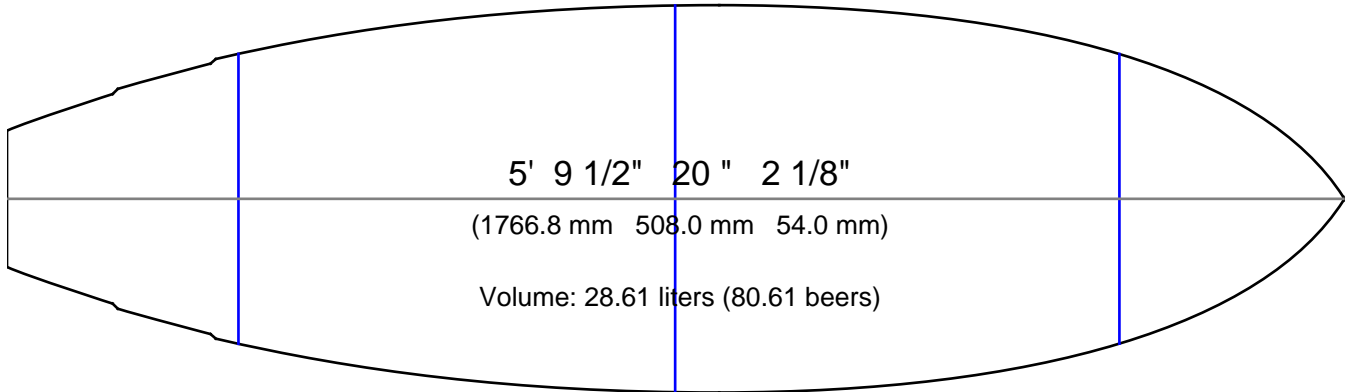

Measurements are center, one foot in and one foot back, over curve.

Comments:

Similar to LOST RNF

ORIGINAL. Back fin at 3.5, Side fins at 10.125, 1.325, 1/4 tow. 2.25 inch deep swallow tail.



AKU SHAPER

Customer:

Date: Jan 19, 2010

Length: 5' 8" (1728.6)

Width: 21" (533.5)

Thickness: 2 3/4" (70.6)

Tail Stop: 35 7/16" (900.0)

Designed by: Octopus

File: BonzerShape

Blank:

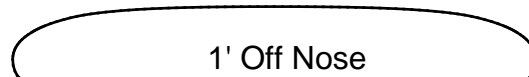
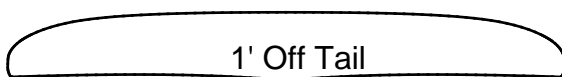
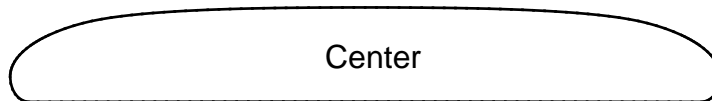
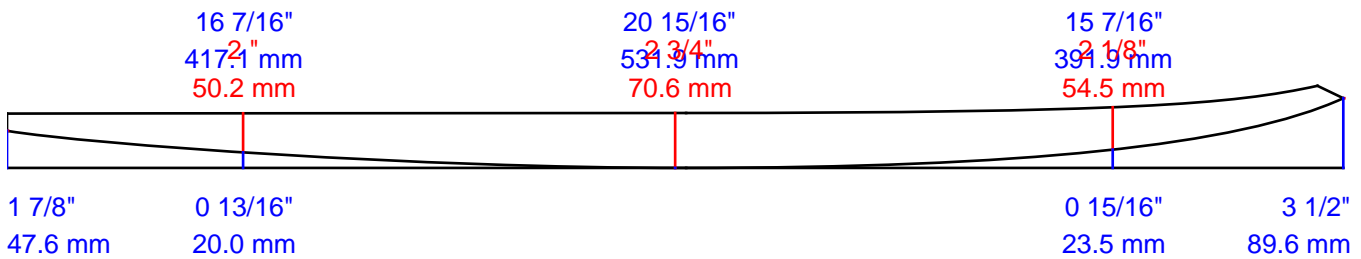
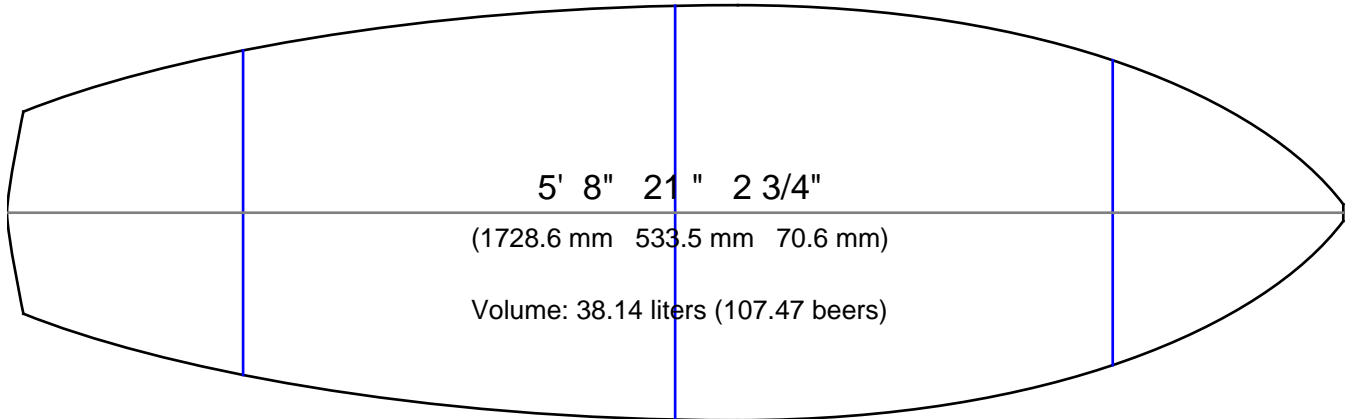

Measurements are center, one foot in and one foot back, over curve.

Comments:

Similar to Campbell Bonzer.

Original. Back fin at 4-7/8. Back 2 at 11.5 and 1.75 off rail. Front 2 at 15 and 1.75 off rail.



AKU SHAPER

Customer:

Date: Jan 19, 2010
Length: 6' 1 1/4" (1859.9)
Width: 21 1/8" (536.6)
Thickness: 2 1/2" (63.1)
Tail Stop: 35 7/16" (900.0)

Designed by: Octopus

File: LanceShape
Blank:

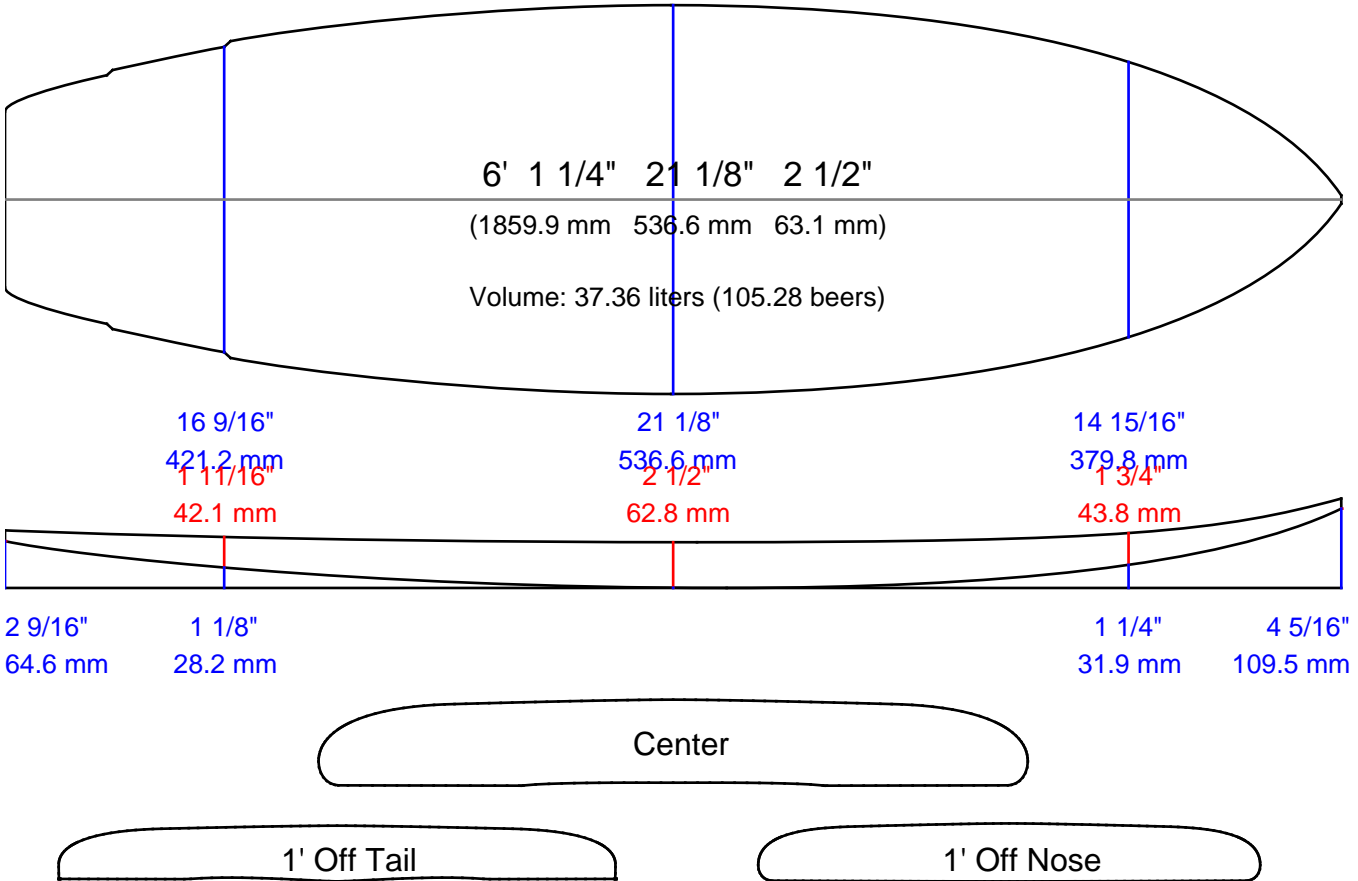

Measurements are center, one foot in and one foot back, over curve.

Comments:

ORIGINAL. Quad. Back fins at 6.5, forward fins at 11, no tow. Extra charge for channel. Deep swallow tail per template.



AKU SHAPER

Customer:

Date: Jan 19, 2010

Length: 5' 8" (1727.8)

Width: 20 1/4" (514.3)

Thickness: 2 3/4" (69.1)

Tail Stop: 35 7/16" (900.0)

Designed by: Octopus

File: QuantumShape

Blank:

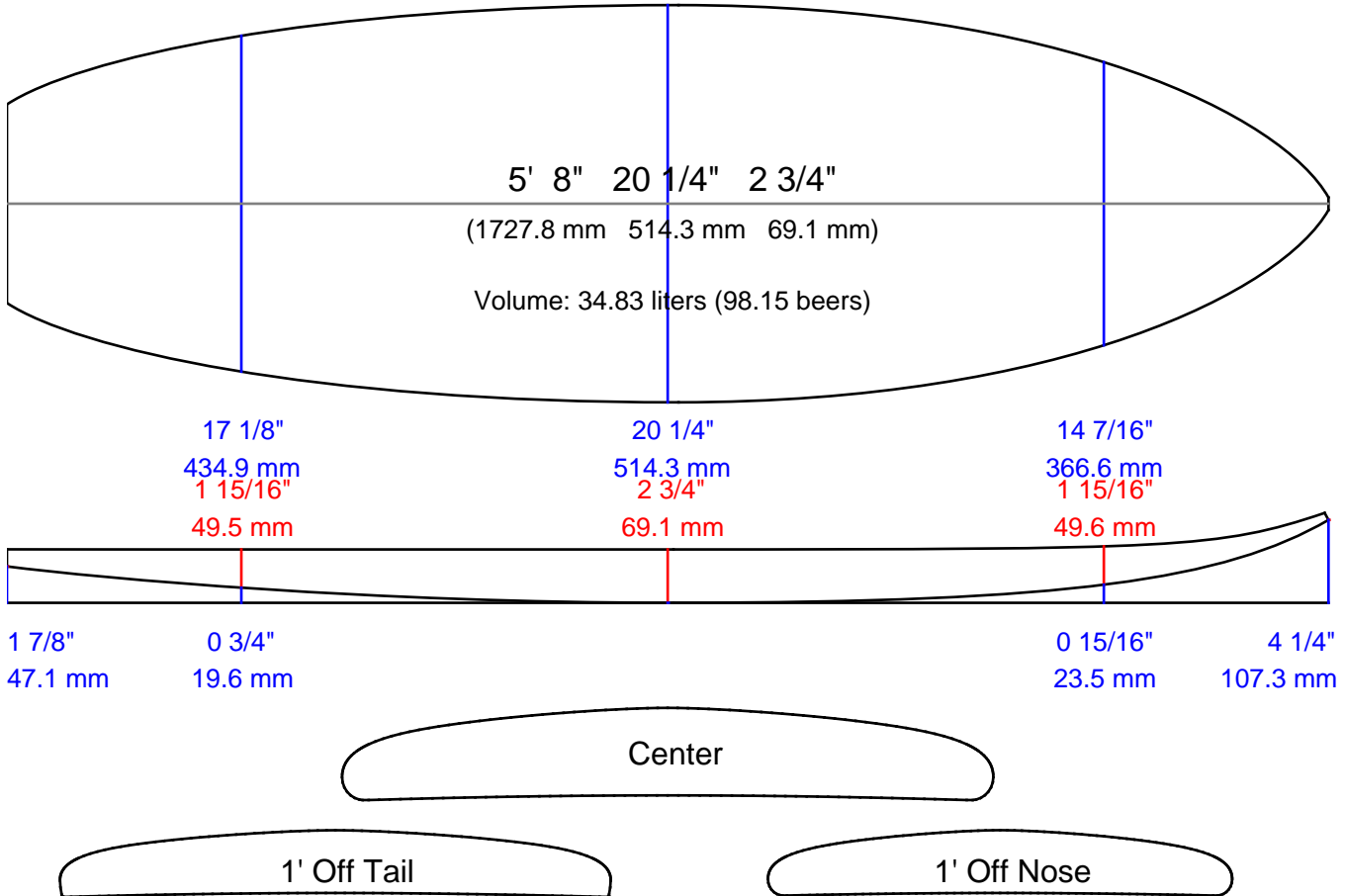

Measurements are center, one foot in and one foot back, over curve.

Comments:

Similar to CI Fishcuit.

Quad. Front fins at 10.75 off tail and 1.25 off rail. Back fins at 5 off tail and 1.25 off rail. Swallow tail 3" deep.



AKU SHAPER

Customer:

Date: Jan 19, 2010

Length: 6' 2" (1880.6)

Width: 19" (483.3)

Thickness: 2 1/2" (62.7)

Tail Stop: 35 7/16" (900.0)

Designed by: Hopper

File: RetroHippyShape

Blank: U.S. Foam 6'5A mns.38ns.+38tl

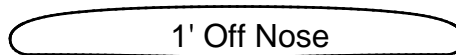
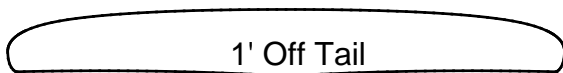
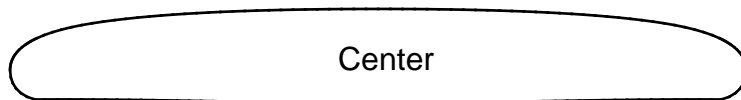
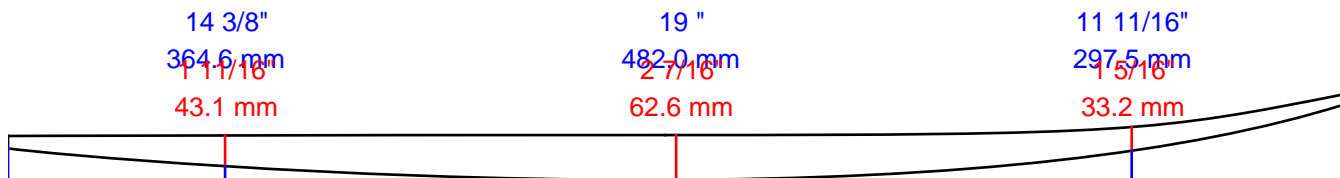
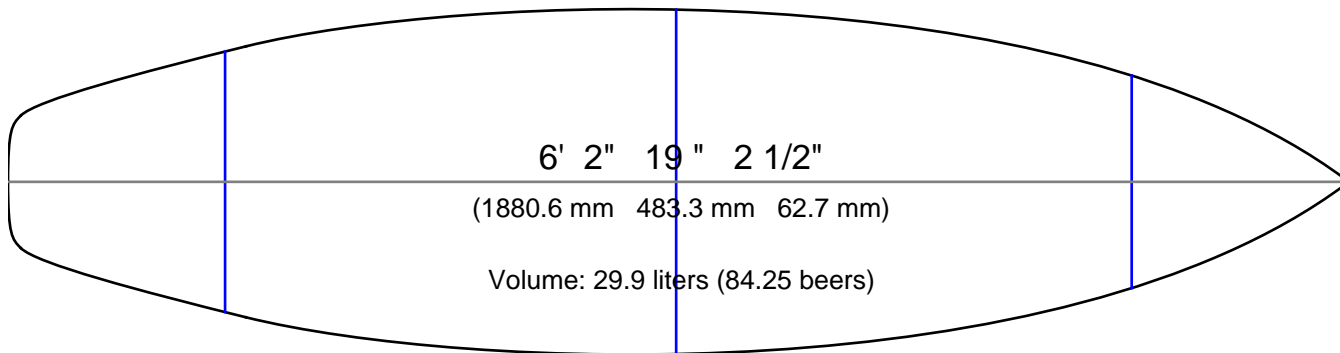

Measurements are center, one foot in and one foot back, over curve.

Comments:

Similar to CI Red Beauty.

Back fin at 3.5. Side fin at 10-7/8 and 1.25 off rail. 1/4 inch tow.

Finish sand with edge along bottom rail tuck for length of board.



AKU SHAPER

Customer:

Date: Jan 19, 2010

Length: 6' 2" (1879.5)

Width: 20 5/8" (523.9)

Thickness: 3" (75.6)

Tail Stop: 35 7/16" (900.0)

Designed by: Octopus

File: RetroTwinShape

Blank:

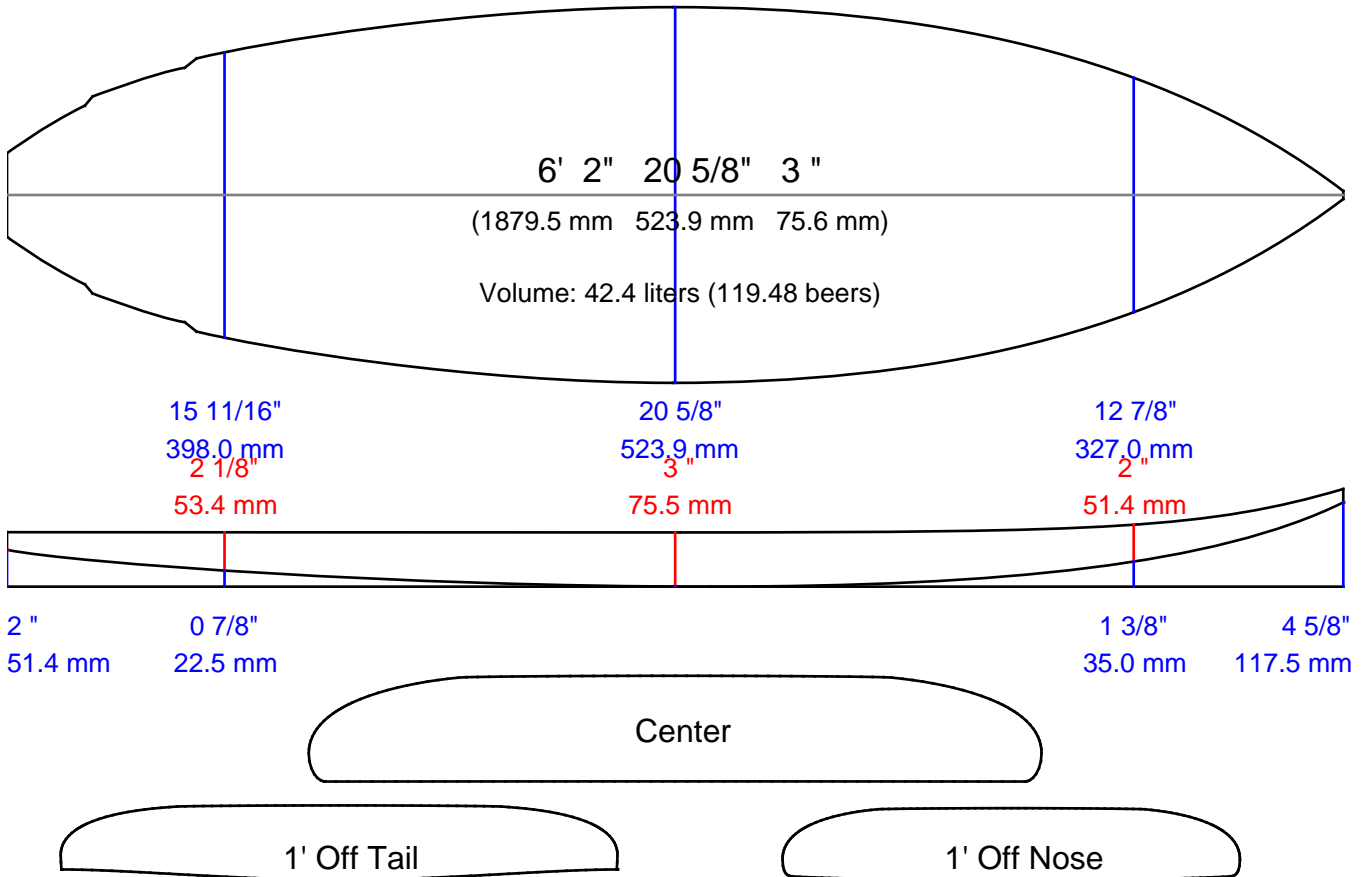

Measurements are center, one foot in and one foot back, over curve.

Comments:

Similar to 1980's CI Tri-Hull Twinner.

ORIGINAL. Fins at 10.5 and 5.75 off stringer. 1/4 tow. 1" deep swallow.



AKU SHAPER

Customer:

Date: Jan 19, 2010

Length: 5' 4 5/8" (1642.4)

Width: 19 1/2" (495.3)

Thickness: 2 1/4" (57.5)

Tail Stop: 35 7/16" (900.0)

Designed by: Octopus

File: SaucerShape

Blank:

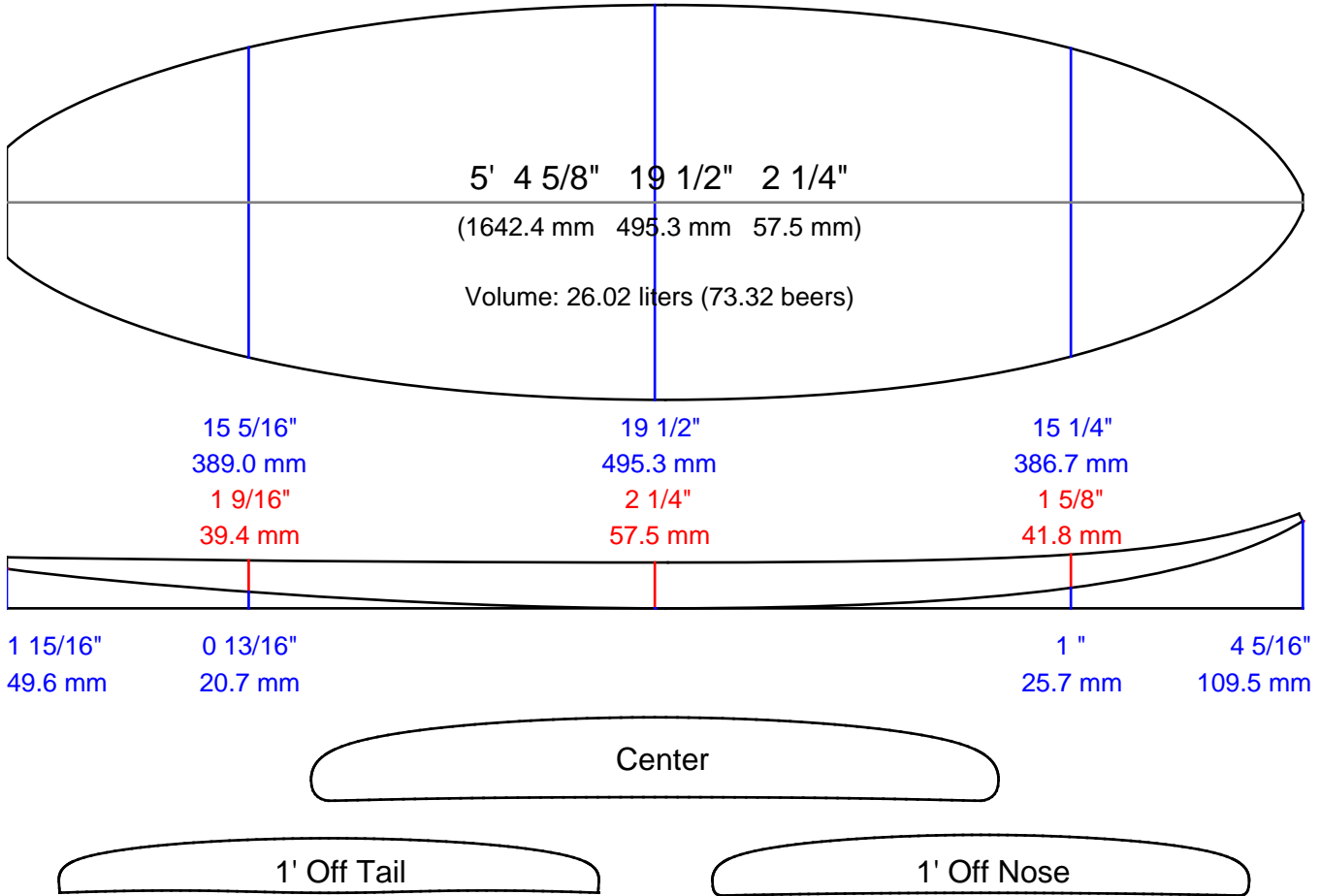

Measurements are center, one foot in and one foot back, over curve.

Comments:

Similar to CI Pod.

Thruster or Quad. Front fins at 10.5 off tail and 1.25 off rail. Back fins at 5 off tail and 2.25 off rail. Swallow tail 1.5" deep. 3/16 tow.